

■ Threaded pin DIN 976-1 V2A M8 x 70 mm

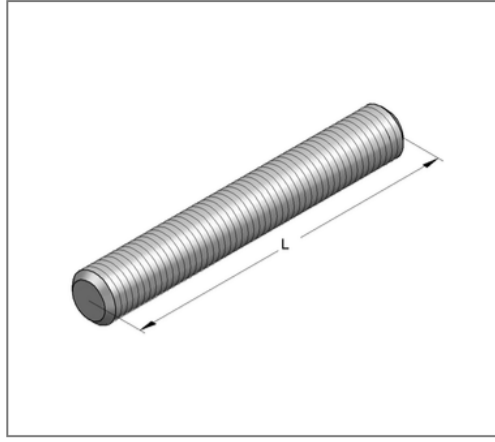
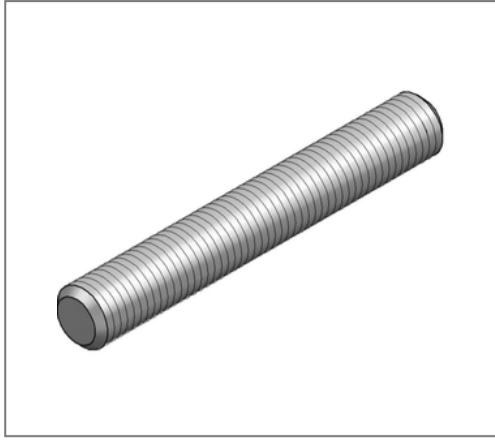

Commercial details

Part no.	0732170
EAN/GTIN	4250928416858
Packing unit	100 pcs
Quantity unit	pcs
Weight	0,0232 kg/pc
Product group	13-048
Price unit	100

QR code



Certification



Technical data

Material	Stainless steel
Material type	V2A
Surrounding area	Indoor and outdoor areas

Product details

Thread	M8
Length L	70 mm
Tension load	15,68 kN