

■ Base plate Type I V2A Connection M16 Plate 115x35x4 mm

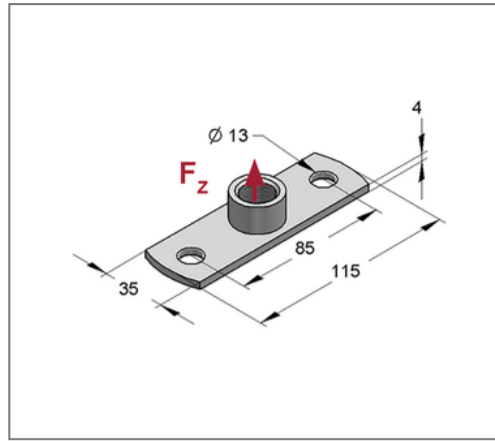
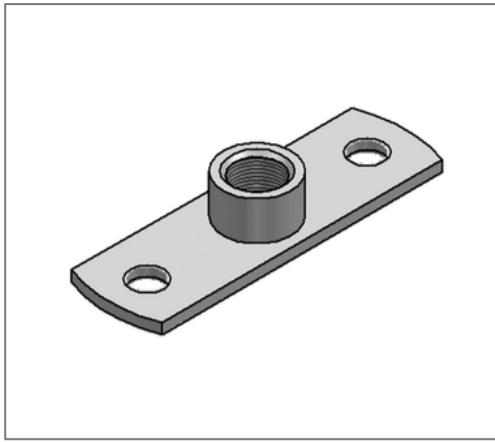

Commercial details

Part no.	0599088
EAN/GTIN	4250928415509
Packing unit	1 pcs
Quantity unit	pcs
Weight	0,159 kg/pc
Product group	13-048
Price unit	100

QR code



Certification



Specification

Number of fixing holes	2 pcs
------------------------	-------

Technical data

Material	Stainless steel
Material type	V2A
Surrounding area	Indoor and outdoor areas

Product details

Connection	M16
Length	115 mm
Width	35 mm
Thickness	4 mm
Load F_z	1,35 kN
Hole distance lengthwise	85 mm