

## ■ Base plate Type I V2A Connection M10 Plate 115x35x4 mm

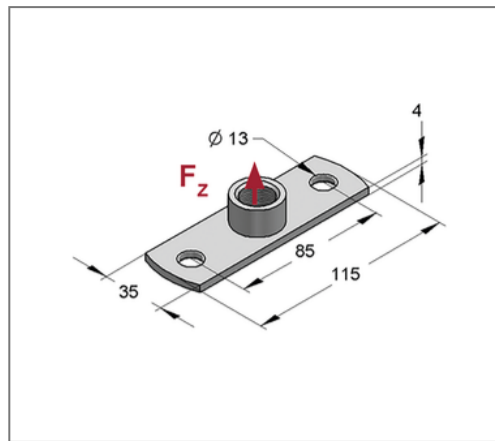
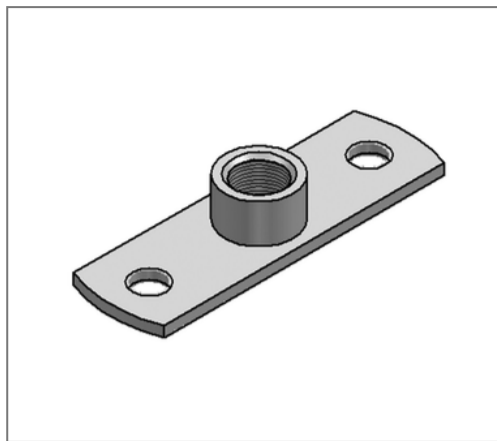

### Commercial details

Part no.	0599495
EAN/GTIN	4250928415523
Packing unit	1 pcs
Quantity unit	pcs
Weight	0,132 kg/pc
Product group	13-048
Price unit	100

### QR code



### Certification



### Specification

Number of fixing holes	2 pcs
------------------------	-------

### Technical data

Material	Stainless steel
Material type	V2A
Surrounding area	Indoor and outdoor areas

### Product details

Connection	M10
Length	115 mm
Width	35 mm
Thickness	4 mm
Load $F_z$	1,35 kN
Hole distance lengthwise	85 mm