

■ Base plate Type I V4A Connection M8 Plate 115x35x4 mm

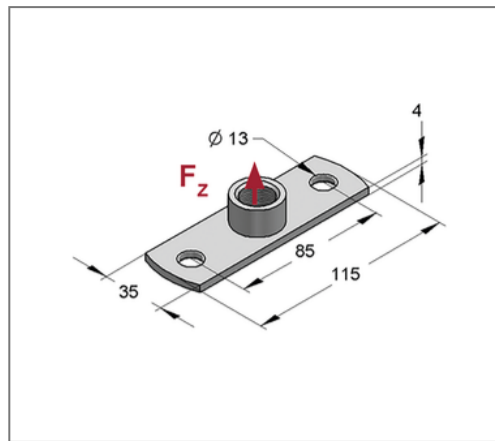
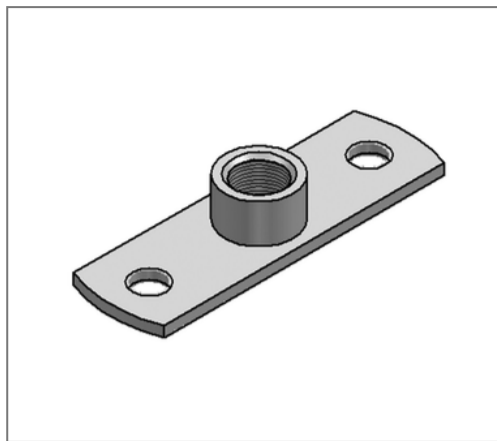

Commercial details

Part no.	0598479
EAN/GTIN	4250928415424
Packing unit	1 pcs
Quantity unit	pcs
Weight	0,125 kg/pc
Product group	13-054
Price unit	100

QR code



Certification



Specification

Number of fixing holes	2 pcs
------------------------	-------

Technical data

Material	Stainless steel
Material type	V4A
Surrounding area	Indoor and outdoor areas

Product details

Connection	M8
Length	115 mm
Width	35 mm
Thickness	4 mm
Load F_z	1,35 kN
Hole distance lengthwise	85 mm