

■ Fixpoint Type A Size 2 V2A 76,1 mm TPE with welding nose

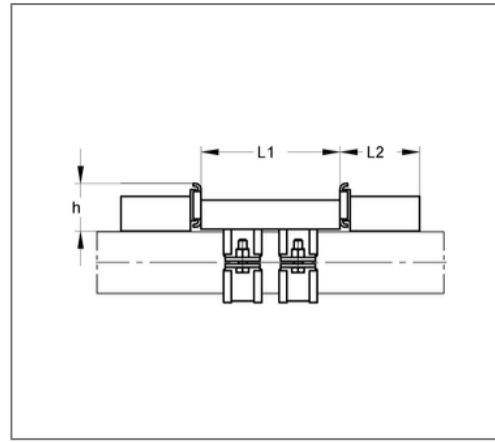
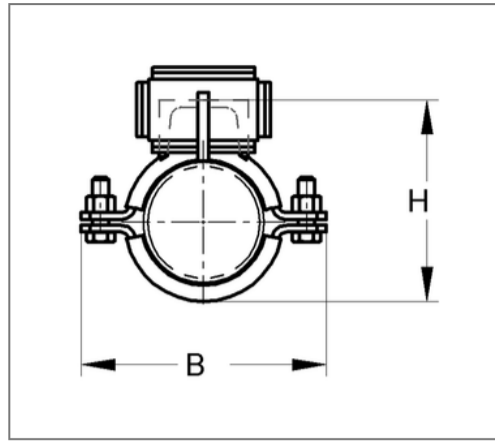
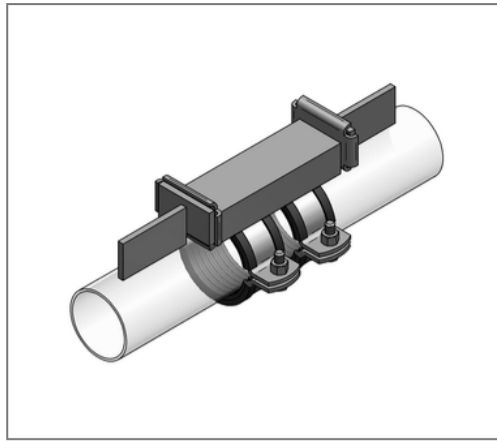

Commercial details

Part no.	9999355
EAN/GTIN	4250928447067
Packing unit	1 pcs
Quantity unit	pcs
Weight	4,99 kg/pc
Product group	13-993
Price unit	1

QR code



Certification



Specification

Application area	Sound-decoupled fixpoint for welding to stainless steel pipes.
Number of pipe clamps	2
Specification	with welding nose
Clip size	2
Profile steel type	U
Pipe clamp type	Titan HD

Technical data

Material type	V2A
min. temperature resistance	-35 °C
max. temperature resistance	100 °C
Sound insulation lining	TPE
Material carrier and clamps	Steel
Material type carrier and clamps	S235
Material pressure pieces	Stainless steel
Material type pressure pads	V2A
Surface carrier and clamps	galvanized

Product details

Width B	166 mm
Height H	131,5 mm
Outer pipe diameter	76,1 mm
Measure construction h	63 mm
Width material pipe clamp	50 mm
Width profile steel	65 mm
Height profile steel	42 mm
Length of pressure piece L2	115 mm
Length of profile steel L1	200 mm
Load F_Y	20 kN

Product details

Thickness material pipe clamp

5 mm