

■ Console C-profile 35/21 V2A L= 420 mm Plate vertical

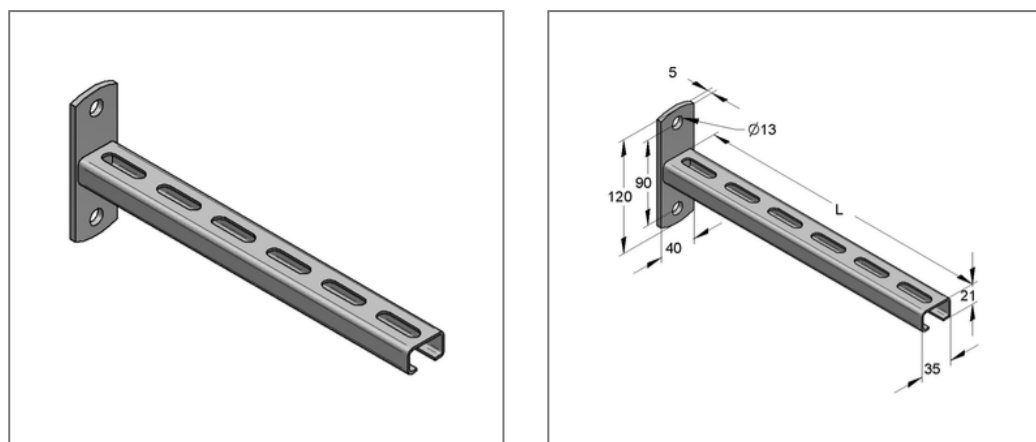

Commercial details

Part no.	0584020
EAN/GTIN	4250928414908
Packing unit	1 pcs
Quantity unit	pcs
Weight	0,689 kg/pc
Product group	13-048
Price unit	1

QR code



Certification



Specification

Application area	Console for the production of cantilever structures for the support of suspended and standing pipe loads.
------------------	---

Technical data

Material	Stainless steel
Material type	V2A
Surrounding area	Indoor and outdoor areas

Product details

Width plate	40 mm
Length plate	120 mm
Hole distance	90 mm
Plate thickness	5 mm
Width profile	35 mm
Profile height	21 mm
Length console L	420 mm
Load F1	0,31 kN
Load F2	0,15 kN
Load q0	0,73 kN/m
Profile thickness	2 mm