

## ■ Ventilation pipe clamp Stainless steel V2A 20x2 mm DN 300 M8 TPE

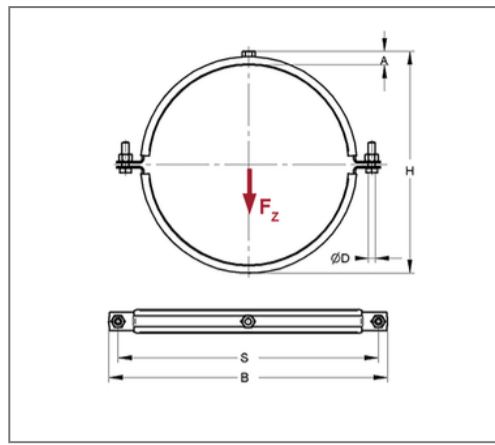

### Commercial details

Part no.	0468143
EAN/GTIN	4250928411976
Packing unit	1 pcs
Quantity unit	pcs
Weight	0,513 kg/pc
Product group	13-046
Price unit	100

### QR code



### Certification



### Specification

Application area	Pipe clamp for fastening ventilation pipes.
Specification	two-part
Connection	M8
Closure	Screwed closure

### Technical data

Material	Stainless steel
Material type	V2A
Surrounding area	Indoor and outdoor areas
Insulation thickness	6 mm
Temperature resistance	-35 °C - 100 °C
Sound insulation lining	TPE

### Product details

Center distance S	360 mm
Connection height A	16 mm
Width B	380 mm
Colour sound insulation lining	black
Height H	331 mm
Material dimension	20x2 mm
Load $F_z$	1 kN
Outer pipe diameter	305 mm
Closure screw	M8

### Remark

Delivery time	2 working days, ex works
Notice	Other sizes and connection threads or with silicone soundinsulation on demand.