

■ Ventilation pipe clamp Stainless steel V2A 20x2 mm DN 125 M8 TPE

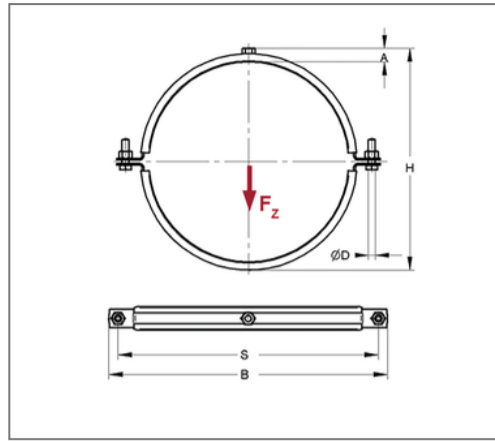

Commercial details

Part no.	0468120
EAN/GTIN	4250928411884
Packing unit	50 pcs
Quantity unit	pcs
Weight	0,226 kg/pc
Product group	13-046
Price unit	100

QR code



Certification



Specification

Application area	Pipe clamp for fastening ventilation pipes.
Specification	two-part
Connection	M8
Closure	Screwed closure

Technical data

Material	Stainless steel
Material type	V2A
Surrounding area	Indoor and outdoor areas
Insulation thickness	6 mm
Temperature resistance	-35 °C - 100 °C
Sound insulation lining	TPE

Product details

Center distance S	181 mm
Connection height A	16 mm
Width B	201 mm
Colour sound insulation lining	black
Height H	154 mm
Material dimension	20x2 mm
Load F_z	1 kN
Outer pipe diameter	129 mm
Closure screw	M6

Remark

Delivery time	2 working days, ex works
Notice	Other sizes and connection threads or with silicone soundinsulation on demand.