

■ Pipe clamp Stainless steel V2A 20x1,5 mm 26 - 30 mm M8 unlined

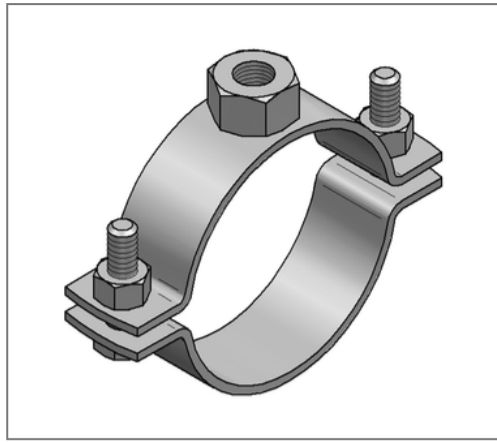

Commercial details

Part no.	0469177
EAN/GTIN	4250928412201
Packing unit	50 pcs
Quantity unit	pcs
Weight	0,0560 kg/pc
Product group	13-046
Price unit	100

QR code



Certification



Specification

Application area	Pipe clamp for fastening pipes.
Specification	two-part
Connection	M8
Closure	Screwed closure

Product details

Center distance S	48 mm
Connection height A	8 mm
Width B	61 mm
Height H	36 - 40 mm
Material dimension	20x1,5 mm
Load F_z	0,8 kN
Clamping range	26 - 30 mm
Outside pipe diameter inch	val.RohraußendurchmesserZoll. 3/4 inch
Closure screw	M6

Technical data

Material	Stainless steel
Material type	V2A
Surrounding area	Indoor and outdoor areas
Sound insulation lining	unlined

Remark

Delivery time	2 working days, ex works
Notice	Other sizes and connection threads on demand.