

## ■ Pipe clamp Stainless steel V4A 35x4 mm 251 - 258 mm M16 unlined

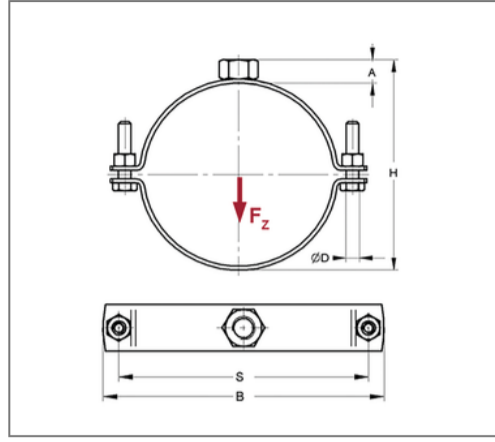
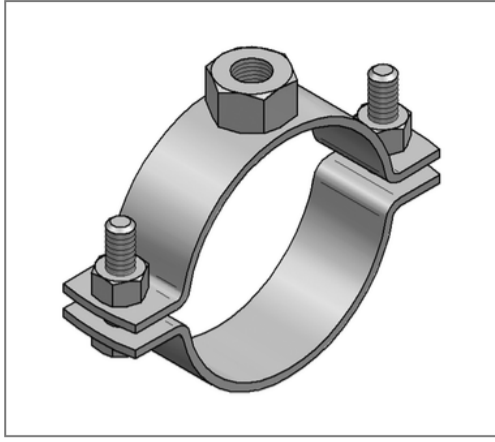

### Commercial details

Part no.	0493435
EAN/GTIN	4250928413352
Packing unit	1 pcs
Quantity unit	pcs
Weight	1,16 kg/pc
Product group	13-049
Price unit	100

### QR code



### Certification



### Specification

Application area	Pipe clamp for fastening pipes.
Specification	two-part
Connection	M16
Closure	Screwed closure

### Product details

Center distance S	303 mm
Connection height A	19 mm
Width B	332 mm
Height H	274 - 281 mm
Material dimension	35x4 mm
Load $F_z$	7,2 kN
Clamping range	251 - 258 mm
Closure screw	M10

### Technical data

Material	Stainless steel
Material type	V4A
Surrounding area	Indoor and outdoor areas
Sound insulation lining	unlined

### Remark

Delivery time	2 working days, ex works
Notice	Other sizes and connection threads on demand.