

■ Pipe clamp Stainless steel V4A 35x4 mm 244 - 250 mm M16 unlined

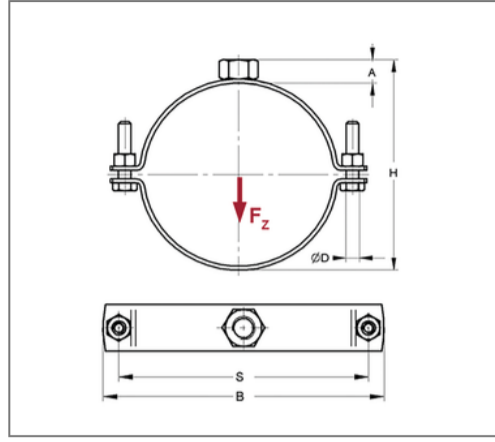
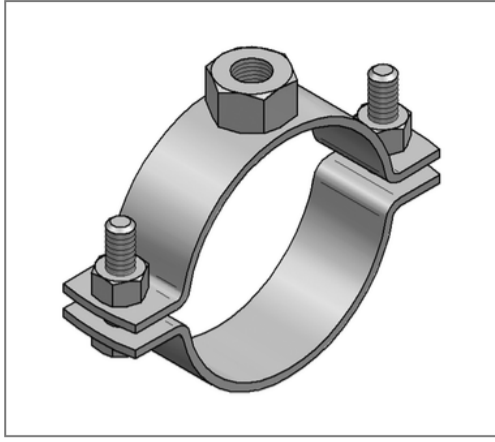

Commercial details

Part no.	0493434
EAN/GTIN	4250928413345
Packing unit	1 pcs
Quantity unit	pcs
Weight	1,13 kg/pc
Product group	13-049
Price unit	100

QR code



Certification



Specification

Application area	Pipe clamp for fastening pipes.
Specification	two-part
Connection	M16
Closure	Screwed closure

Product details

Center distance S	295 mm
Connection height A	19 mm
Width B	324 mm
Height H	267 - 273 mm
Material dimension	35x4 mm
Load F_z	7,2 kN
Clamping range	244 - 250 mm
Closure screw	M10

Technical data

Material	Stainless steel
Material type	V4A
Surrounding area	Indoor and outdoor areas
Sound insulation lining	unlined

Remark

Delivery time	2 working days, ex works
Notice	Other sizes and connection threads on demand.