

■ Pipe clamp Stainless steel V4A 20x2 mm 92 - 100 mm M10 unlined

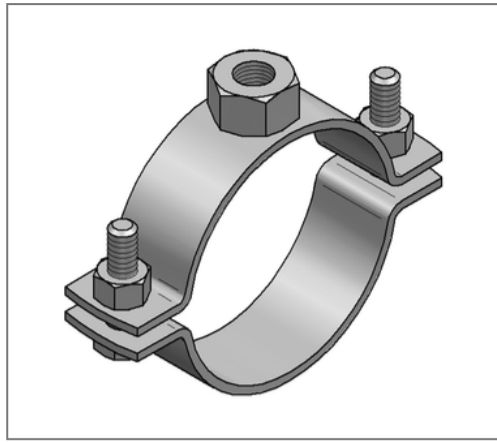

Commercial details

Part no.	0499216
EAN/GTIN	4250928414045
Packing unit	50 pcs
Quantity unit	pcs
Weight	0,143 kg/pc
Product group	13-049
Price unit	100

QR code



Certification



Specification

Application area	Pipe clamp for fastening pipes.
Specification	two-part
Connection	M10
Closure	Screwed closure

Product details

Center distance S	120 mm
Connection height A	10 mm
Width B	134 mm
Height H	104 - 112 mm
Material dimension	20x2 mm
Load F_z	1,5 kN
Clamping range	92 - 100 mm
Closure screw	M6

Technical data

Material	Stainless steel
Material type	V4A
Surrounding area	Indoor and outdoor areas
Sound insulation lining	unlined

Remark

Delivery time	2 working days, ex works
Notice	Other sizes and connection threads on demand.