

## ■ Pipe clamp Stainless steel V4A 20x2 mm 82 - 90 mm M10 unlined

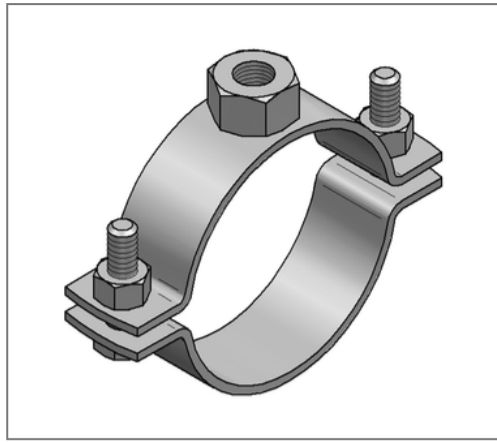

### Commercial details

Part no.	0499215
EAN/GTIN	4250928414038
Packing unit	50 pcs
Quantity unit	pcs
Weight	0,133 kg/pc
Product group	13-049
Price unit	100

### QR code



### Certification



### Specification

Application area	Pipe clamp for fastening pipes.
Specification	two-part
Connection	M10
Closure	Screwed closure

### Product details

Center distance S	110 mm
Connection height A	10 mm
Width B	113 mm
Height H	94 - 102 mm
Material dimension	20x2 mm
Load $F_z$	1,5 kN
Clamping range	82 - 90 mm
Outside pipe diameter inch	val.RohraußendurchmesserZoll.3 inch
Closure screw	M6

### Technical data

Material	Stainless steel
Material type	V4A
Surrounding area	Indoor and outdoor areas
Sound insulation lining	unlined

### Remark

Delivery time	2 working days, ex works
Notice	Other sizes and connection threads on demand.