

## ■ Pipe clamp Stainless steel V4A 20x2 mm 68 - 74 mm M10 unlined

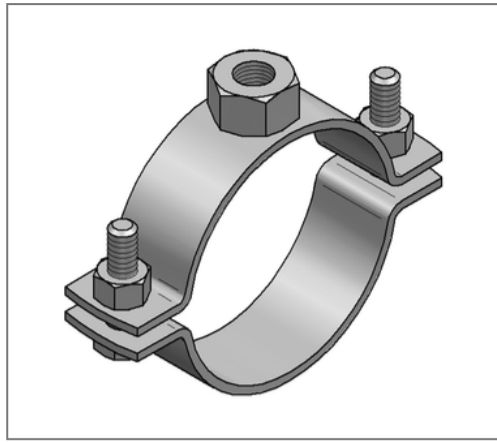

### Commercial details

Part no.	0499213
EAN/GTIN	4250928414014
Packing unit	50 pcs
Quantity unit	pcs
Weight	0,118 kg/pc
Product group	13-049
Price unit	100

### QR code



### Certification



### Specification

Application area	Pipe clamp for fastening pipes.
Specification	two-part
Connection	M10
Closure	Screwed closure

### Product details

Center distance S	94 mm
Connection height A	10 mm
Width B	108 mm
Height H	80 - 86 mm
Material dimension	20x2 mm
Load $F_z$	1,5 kN
Clamping range	68 - 74 mm
Closure screw	M6

### Technical data

Material	Stainless steel
Material type	V4A
Surrounding area	Indoor and outdoor areas
Sound insulation lining	unlined

### Remark

Delivery time	2 working days, ex works
Notice	Other sizes and connection threads on demand.