

■ Pipe clamp Stainless steel V2A 25x3 142 - 149 mm M12 TPE

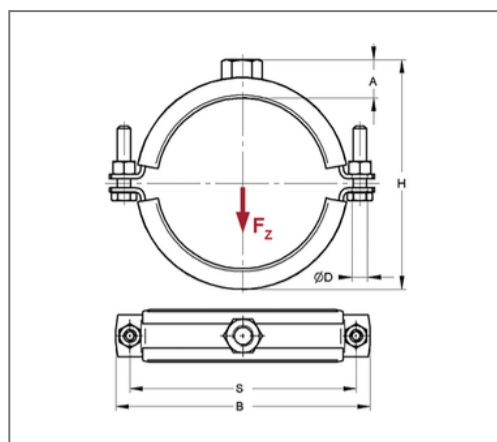
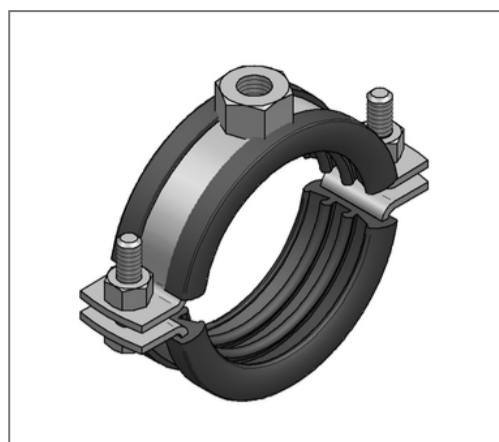

Commercial details

Part no.	0466322
EAN/GTIN	4250928411723
Packing unit	50 pcs
Quantity unit	pcs
Weight	0,483 kg/pc
Product group	13-046
Price unit	100

QR code



Certification



Specification

Application area	Pipe clamp for fastening pipes.
Specification	two-part
Connection	M12
Closure	Screwed closure

Technical data

Material	Stainless steel
Material type	V2A
Surrounding area	Indoor and outdoor areas
Insulation thickness	6 mm
Temperature resistance	-35 °C - 100 °C
Sound insulation lining	TPE

Product details

Center distance S	192 mm
Connection height A	20 mm
Width B	213 mm
Colour sound insulation lining	black
Height H	169 - 176 mm
Material dimension	25x3 mm
Load F_z	1,75 kN
Clamping range	142 - 149 mm
Closure screw	M8

Remark

Delivery time	2 working days, ex works
Notice	Other sizes and connection threads or with silicone soundinsulation on demand.