

## ■ Pipe clamp Stainless steel V2A 25x3 133 - 141 mm M12 TPE

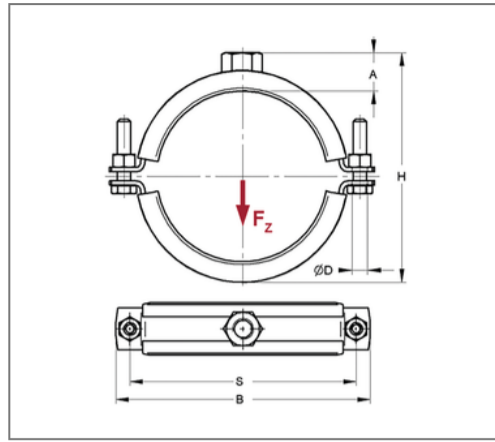
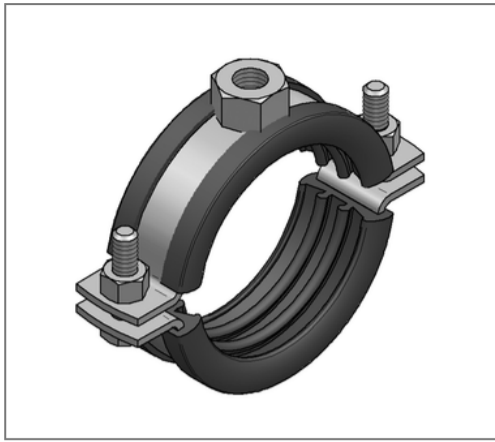

### Commercial details

Part no.	0466321
EAN/GTIN	4250928411716
Packing unit	50 pcs
Quantity unit	pcs
Weight	0,460 kg/pc
Product group	13-046
Price unit	100

### QR code



### Certification



### Specification

Application area	Pipe clamp for fastening pipes.
Specification	two-part
Connection	M12
Closure	Screwed closure

### Technical data

Material	Stainless steel
Material type	V2A
Surrounding area	Indoor and outdoor areas
Insulation thickness	6 mm
Temperature resistance	-35 °C - 100 °C
Sound insulation lining	TPE

### Product details

Center distance S	184 mm
Connection height A	20 mm
Width B	205 mm
Colour sound insulation lining	black
Height H	160 - 168 mm
Material dimension	25x3 mm
Load $F_z$	1,75 kN
Clamping range	133 - 141 mm
Outside pipe diameter inch	val.RohraußendurchmesserZoll. 5 inch
Closure screw	M8

### Remark

Delivery time	2 working days, ex works
Notice	Other sizes and connection threads or with silicone soundinsulation on demand.