

## ■ Console C-profile 45/45 SP L= 420 mm Plate horizontal galv.

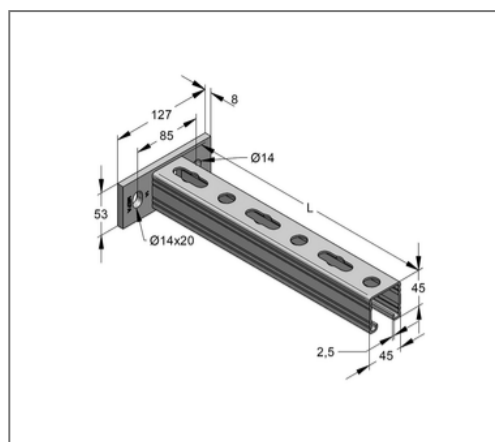

### Commercial details

Part no.	9992220
EAN/GTIN	4250928448927
Packing unit	10 pcs
Quantity unit	pcs
Weight	1,61 kg/pc
Product group	02-083
Price unit	1

### QR code



### Specification

Application Console for the production of cantilever structures  
area for the support of suspended and standing pipe  
loads for sprinkler piping.

### Technical data

Material	Steel
Surface	galvanized
Corrosion category	C2 very high
Surrounding area	Indoor area

### Product details

Width plate	50 mm
Length plate	127 mm
Hole distance	85 mm
Plate thickness	6 mm
Width profile	45 mm
Profile height	45 mm
Length console L	420 mm
Elongated hole plate	14x20 mm
Load F1	1,84 kN
Load F2	0,92 kN
Load q0	4,38 kN/m
Profile thickness	2,5 mm