

## ■ Console C-profile 45/45 SP L= 315 mm Plate horizontal galv.

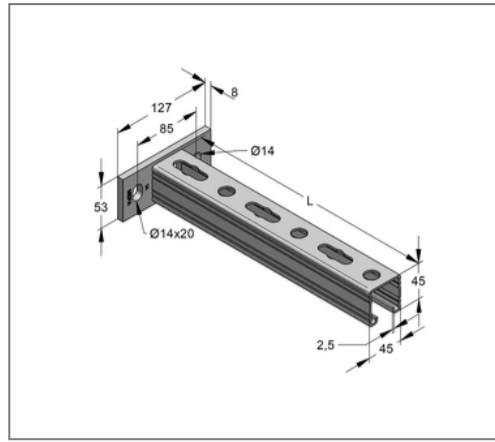
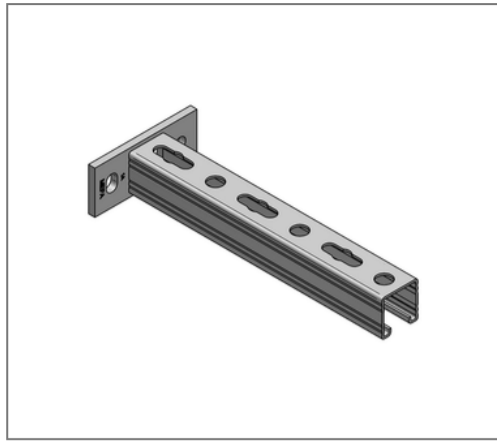

### Commercial details

Part no.	9992219
EAN/GTIN	4250928448910
Packing unit	15 pcs
Quantity unit	pcs
Weight	1,30 kg/pc
Product group	02-083
Price unit	1

### QR code



### Specification

Application Console for the production of cantilever structures  
area for the support of suspended and standing pipe  
loads for sprinkler piping.

### Technical data

Material	Steel
Surface	galvanized
Corrosion category	C2 very high
Surrounding area	Indoor area

### Product details

Width plate	50 mm
Length plate	127 mm
Hole distance	85 mm
Plate thickness	6 mm
Width profile	45 mm
Profile height	45 mm
Length console L	315 mm
Elongated hole plate	14x20 mm
Load F1	2,45 kN
Load F2	1,23 kN
Load q0	7,78 kN/m
Profile thickness	2,5 mm