

■ Ventilation pipe clamp Standard 20x2,5 DN 224 without connection unlined

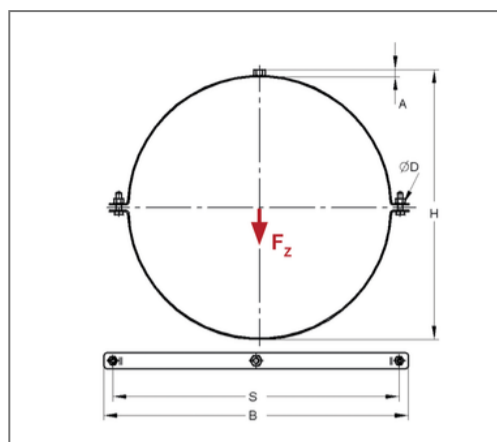

Commercial details

Part no.	0432250
EAN/GTIN	4250928409935
Packing unit	1 pcs
Quantity unit	pcs
Weight	0,318 kg/pc
Product group	08-043
Price unit	100

QR code



Specification

Application area	Pipe clamp for fastening ventilation pipes.
Specification	two-part
Connection	without connection
Closure	Nut / closure screw

Technical data

Material	Steel
Material type	S235
Surface	galvanized
Corrosion category	C2 very high
Surrounding area	Indoor area
Sound insulation lining	unlined

Product details

Center distance S	262 mm
Width B	287 mm
Height H	233 mm
Material dimension	20x2,5 mm
Load F_z	2 kN
Outer pipe diameter	227 mm
Hole diameter D	8,5 mm