

■ Ventilation pipe clamp Standard 20x2 DN 160 M8 TPE

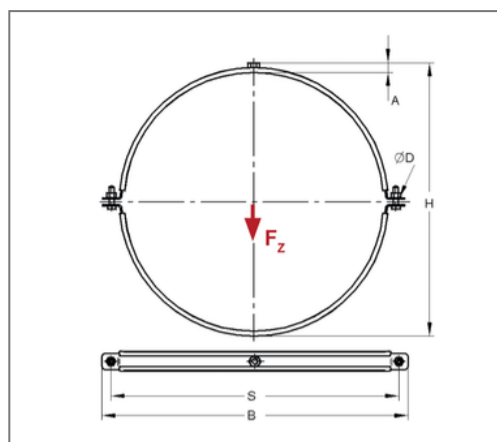

Commercial details

Part no.	0431601
EAN/GTIN	4250928409751
Packing unit	1 pcs
Quantity unit	pcs
Weight	0,334 kg/pc
Product group	08-043
Price unit	100

QR code



Certification



Specification

Application area	Pipe clamp for fastening ventilation pipes.
Specification	two-part
Connection	M8
Closure	Nut / closure screw

Technical data

Material	Steel
Material type	S235
Surface	galvanized
Corrosion category	C2 very high
Surrounding area	Indoor area
Insulation thickness	6 mm
Temperature resistance	-35 °C - 100 °C
Sound insulation lining	TPE

Product details

Center distance S	210 mm
Connection height A	22 mm
Width B	235 mm
Colour sound insulation lining	black
Height H	193 mm
Material dimension	20x2 mm
Load Fz	0,8 kN
Outer pipe diameter	163 mm
Hole diameter D	8,5 mm
Closure screw	M8