

## ■ Conical stud V A M10 V4A Length 130 mm

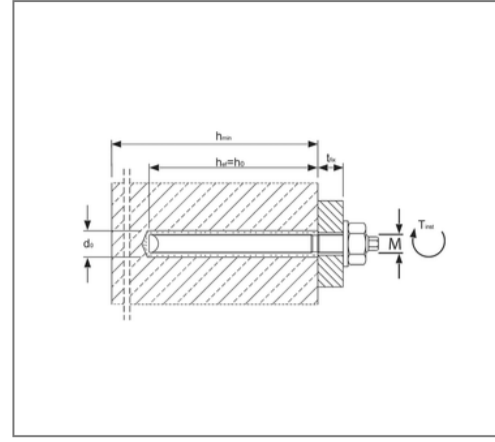
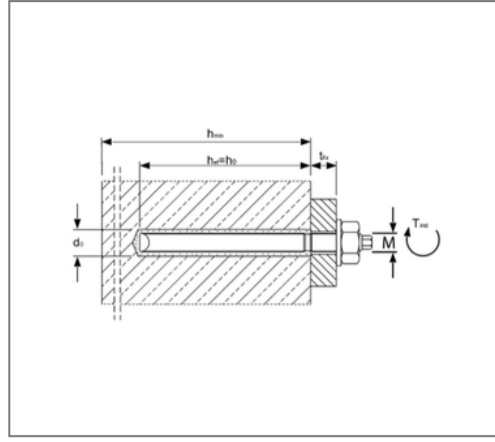

### Commercial details

Part no.	222821203501
EAN/GTIN	4043315019882
Packing unit	10 pcs
Quantity unit	pcs
Weight	0,0810 kg/pc
Product group	07-222
Price unit	1

### QR code



### Certification



### Specification

Application area	For non-cracked concrete C12/15 to C50/60.
Brand	MKT

### Product details

Drill diameter	12 mm
Drilling hole depth	90 mm
max. clamping thickness	30 mm
Depth of anchoring	90 mm
Wrench size nut	17
Wrench size anchor rod	6
Type of mortar cartridge	VZ-P 10
Length	130 mm
Thread	M10

### Technical data

Material	Stainless steel
Material type	V4A

### Remark

Delivery time	3 working days, ex works
---------------	--------------------------