

■ Bolt anchor BZ plus M8 Length thread 52 mm Steel

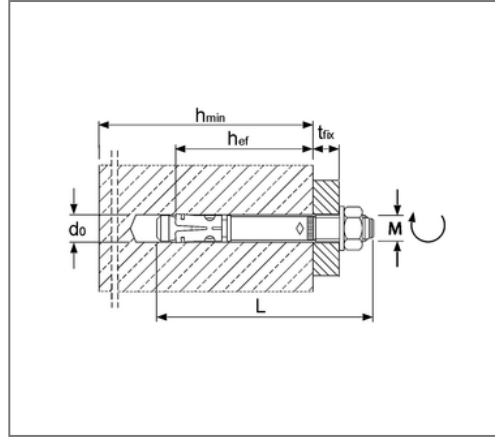

Commercial details

Part no.	221108030
EAN/GTIN	4043315045393
Packing unit	100 pcs
Quantity unit	pcs
Weight	0,0360 kg/pc
Product group	07-221
Price unit	100

QR code



Certification



Specification

Brand	MKT
Application area	Anchoring of medium to heavy loads in cracked and uncracked concrete: supports, steel beams, railing fixings, cable trays, wooden structures and brackets.

Technical data

Material	Steel
Surface	galvanized

Product details

Clamping thickness	30 mm
max. clamping thickness red.	41 mm
Drill diameter	8 mm
Drilling hole depth	60 mm
Drilling hole depth red.	49 mm
Setting depth	52 mm
Depth of anchoring	46 mm
Depth of anchoring red.	35 mm
Length dowel	95 mm
Thread	M8

Remark

Delivery time	V4A - 3 working days, ex works
---------------	--------------------------------