

■ Insulated pipe clamp RG80 ALU/PU 33,7 mm Insulation 50 x 100 mm M10/M12

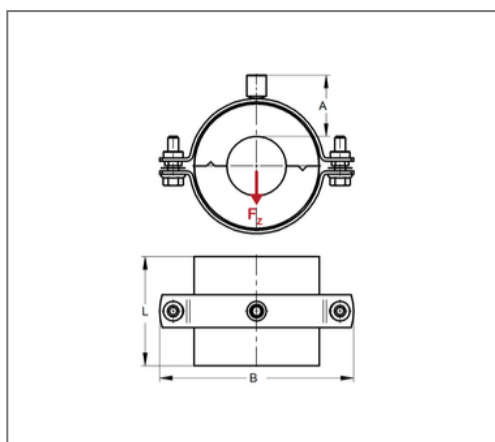
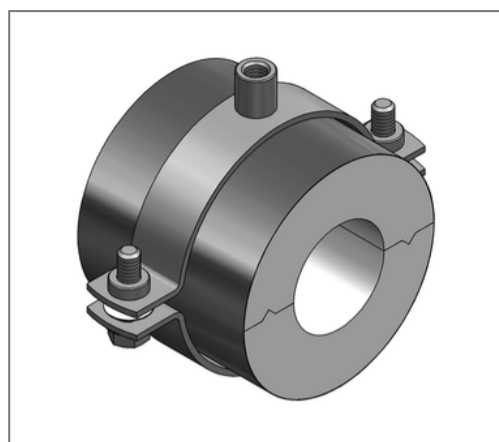

Commercial details

Part no.	76503444
EAN/GTIN	4250928445018
Packing unit	1 pcs
Quantity unit	pcs
Weight	0,815 kg/pc
Product group	06-765
Price unit	1

QR code



Certification



Specification

Application area	A thermal decoupled mounting of tubes guarantees a reliable prevention of condensate for refrigeration, air-conditioning and drinking water technologies in the sector pipe-clamping.
Insulation body	ALU/PU

Technical data

Material	Steel
Material type	S235
Material coat	Aluminum foil
Surface	galvanized
Corrosion category	C2 very high
Surrounding area	Indoor area
Class	B2
min. temperature resistance	-80 °C
max. temperature resistance	120 °C
Thermal conductivity	0,025 W/mK
Density shell	80 kg/m ³
Density coat	2700 kg/m ³
Thicknes coat	0,08 mm
Water vapour diffusion resistance	18750 μ

Product details

Connection	M10/M12
Connection height A	76 mm
Width B	209 mm
Insulation thickness	50 mm
Load F _z	0,5 kN

Remark

Delivery time	5 working days, ex works
Notice	exchange and returns are excluded.

Product details

Length shell L	100 mm
Statical load shell	0,1 N/mm ²