

■ Insulated pipe clamp Husky II 13 114,3 mm Insulation 15,9 M10/M12

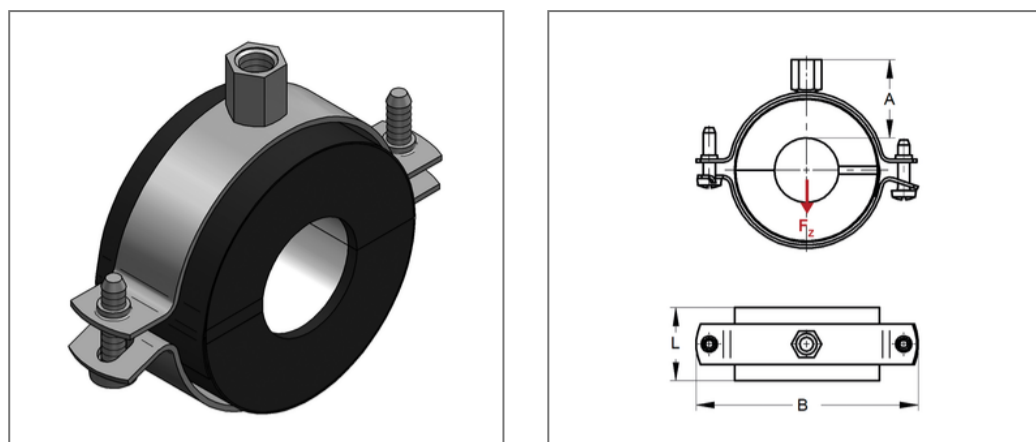

Commercial details

Part no.	6831141
EAN/GTIN	4250928440600
Packing unit	4 pcs
Quantity unit	pcs
Weight	0,358 kg/pc
Product group	06-683
Price unit	1

QR code



Certification



Specification

Application area	A thermal decoupled mounting of tubes guarantees a reliable prevention of condensate for refrigeration, air-conditioning and drinking water technologies in the sector pipe-clamping.
Insulation body	KA/PU

Technical data

Material	Steel
Material type	DD11
Material coat	Plastic
Surface	galvanized
Corrosion category	C2 very high
Surrounding area	Indoor area
Class	B2
min. temperature resistance	-45 °C
max. temperature resistance	105 °C
Thermal conductivity	0,029 W/mK
Density shell	120 kg/m ³
Water vapour diffusion resistance	20000 μ

Product details

Connection	M10/M12
Connection height A	40 mm
Width B	192 mm
Insulation thickness	15,9 mm
Load F _z	0,97 kN
Length shell L	42 mm
Statical load shell	0,27 N/mm ²

Remark

Notice exchange and returns are excluded. Special design on request.