

■ Insulated pipe clamp Husky II 13 57 mm Insulation 14 M8/M10

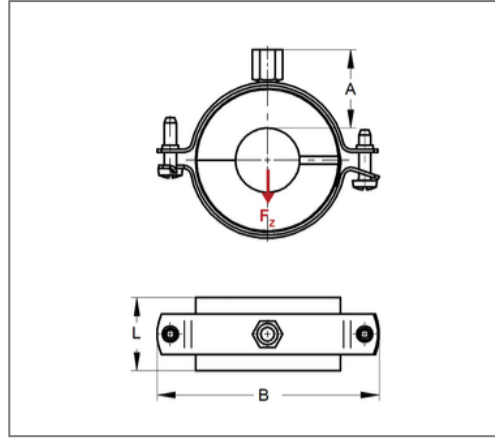
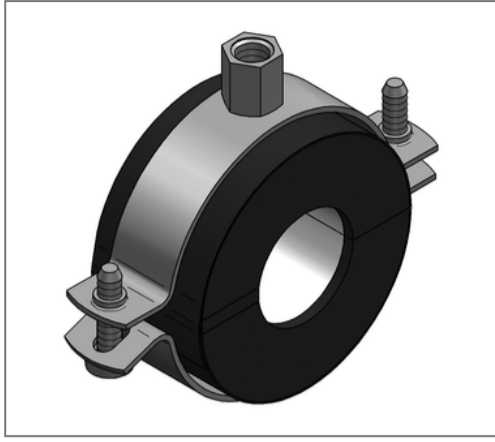

Commercial details

Part no.	6830570
EAN/GTIN	4250928440525
Packing unit	10 pcs
Quantity unit	pcs
Weight	0,149 kg/pc
Product group	06-683
Price unit	1

QR code



Certification



Specification

Application area	A thermal decoupled mounting of tubes guarantees a reliable prevention of condensate for refrigeration, air-conditioning and drinking water technologies in the sector pipe-clamping.
Insulation body	KA/PU

Technical data

Material	Steel
Material type	DD11
Material coat	Plastic
Surface	galvanized
Corrosion category	C2 very high
Surrounding area	Indoor area
Class	B2
min. temperature resistance	-45 °C
max. temperature resistance	105 °C
Thermal conductivity	0,029 W/mK
Density shell	120 kg/m ³
Water vapour diffusion resistance	20000 μ

Product details

Connection	M8/M10
Connection height A	33 mm
Width B	124 mm
Insulation thickness	14 mm
Load F _z	0,48 kN
Length shell L	42 mm
Statical load shell	0,27 N/mm ²

Remark

Notice	exchange and returns are excluded. Special design on request.
Note	delivery time on demand