

■ Insulated pipe clamp Husky II 13 31,8 mm Insulation 12,5 M8/M10

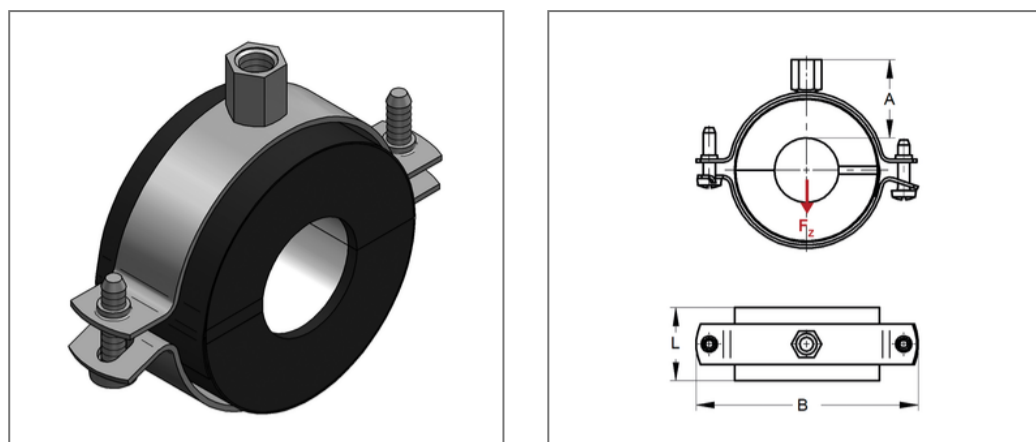

Commercial details

Part no.	6830320
EAN/GTIN	4250928440440
Packing unit	12 pcs
Quantity unit	pcs
Weight	0,0981 kg/pc
Product group	06-683
Price unit	1

QR code



Certification



Specification

Application area	A thermal decoupled mounting of tubes guarantees a reliable prevention of condensate for refrigeration, air-conditioning and drinking water technologies in the sector pipe-clamping.
Insulation body	KA/PU

Technical data

Material	Steel
Material type	DD11
Material coat	Plastic
Surface	galvanized
Corrosion category	C2 very high
Surrounding area	Indoor area
Class	B2
min. temperature resistance	-45 °C
max. temperature resistance	105 °C
Thermal conductivity	0,029 W/mK
Density shell	120 kg/m ³
Water vapour diffusion resistance	20000 μ

Product details

Connection	M8/M10
Connection height A	32 mm
Width B	94 mm
Insulation thickness	12,5 mm
Load F _z	0,22 kN
Length shell L	36 mm
Statical load shell	0,27 N/mm ²

Remark

Notice exchange and returns are excluded. Special design on request.