

## ■ Insulated pipe clamp Polar Plus 63,5 mm Insulation 30 M8/M10

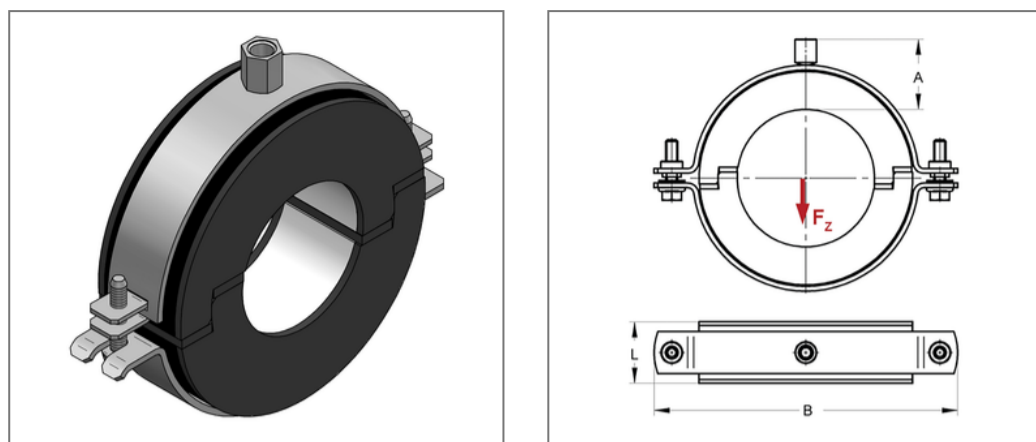

### Commercial details

Part no.	74630640
EAN/GTIN	4250928442734
Packing unit	15 pcs
Quantity unit	pcs
Weight	0,296 kg/pc
Product group	06-746
Price unit	1

### QR code



### Certification



### Specification

Application area	A thermal decoupled mounting of tubes guarantees a reliable prevention of condensate for refrigeration, air-conditioning and drinking water technologies in the sector pipe-clamping.
Insulation body	AC/PU

### Technical data

Material	Steel
Material type	DD11
Surface	galvanized
Corrosion category	C2 very high
Surrounding area	Indoor area
Class	B2
min. temperature resistance	-50 °C
max. temperature resistance	105 °C
Thermal conductivity	0,03 W/mK
Density shell	145 kg/m <sup>3</sup>
Water vapour diffusion resistance	36000 μ

### Product details

Connection	M8/M10
Connection height A	48 mm
Width B	158 mm
Insulation thickness	30 mm
Load F <sub>z</sub>	0,74 kN
Length shell L	41 mm
Statical load shell	0,38 N/mm <sup>2</sup>

### Remark

Notice	exchange and returns are excluded. Special design on request.
Note	delivery time on demand