

■ Insulated pipe clamp Polar Plus 28 mm Insulation 20 M8/M10

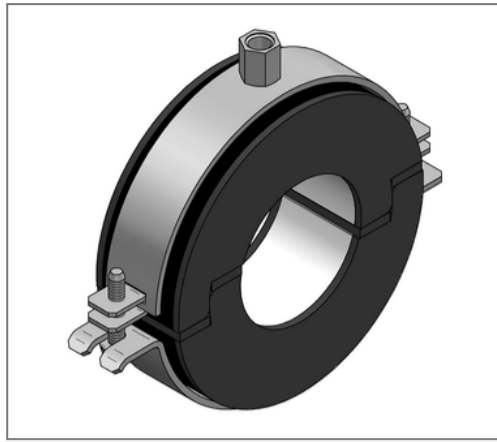

Commercial details

Part no.	74620280
EAN/GTIN	4250928442505
Packing unit	20 pcs
Quantity unit	pcs
Weight	0,125 kg/pc
Product group	06-746
Price unit	1

QR code



Certification



Specification

Application area	A thermal decoupled mounting of tubes guarantees a reliable prevention of condensate for refrigeration, air-conditioning and drinking water technologies in the sector pipe-clamping.
Insulation body	AC/PU

Technical data

Material	Steel
Material type	DD11
Surface	galvanized
Corrosion category	C2 very high
Surrounding area	Indoor area
Class	B2
min. temperature resistance	-50 °C
max. temperature resistance	105 °C
Thermal conductivity	0,031 W/mK
Density shell	145 kg/m ³
Water vapour diffusion resistance	36000 μ

Product details

Connection	M8/M10
Connection height A	37 mm
Width B	101 mm
Insulation thickness	20 mm
Load F _z	0,27 kN
Length shell L	36 mm
Statical load shell	0,38 N/mm ²

Remark

Notice exchange and returns are excluded. Special design on request.