

■ Beam clamp Cast iron F9 Clamping range 32 - 82 mm Hole for M20

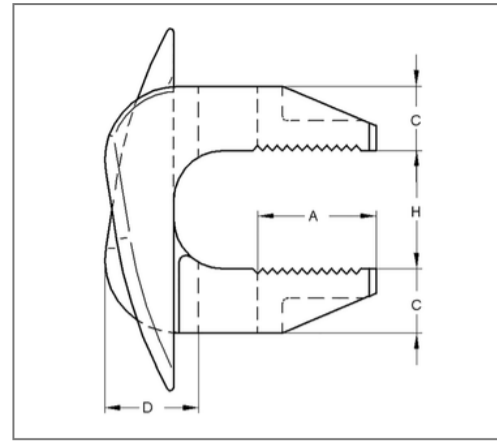
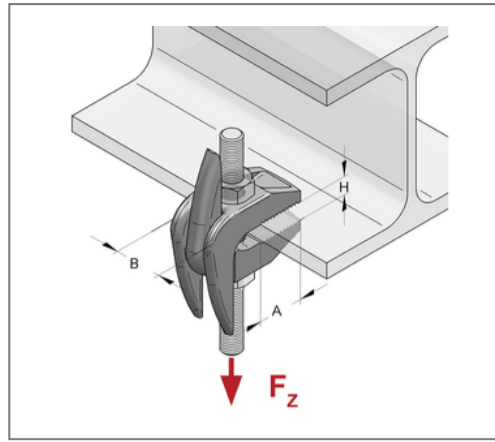
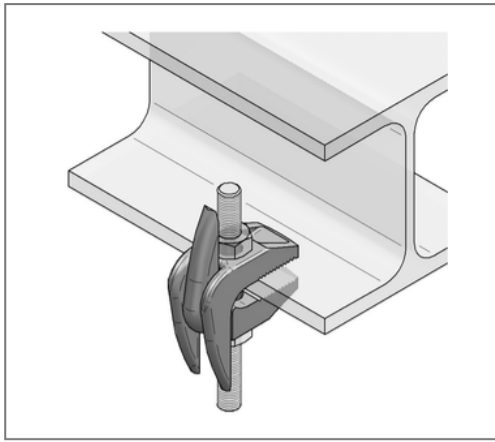

Commercial details

Part no.	0579705
EAN/GTIN	4250928414816
Packing unit	1 pcs
Quantity unit	pcs
Weight	1,28 kg/pc
Product group	05-057
Price unit	1

QR code



Specification

Application area	For mounting suspensions to steel girders. Not suitable for inclined flanges.
Type of attachment	with pass hole

Technical data

Material	Malleable cast iron
Surface	galvanized
Corrosion category	C2 very high
Surrounding area	Indoor area
min. clamping thickness H	32 mm
max. clamping thickness H	82 mm

Product details

Load F_z	8,4 kN
Thread	for M20
Thickness C	25 mm
Tightening torque	177 Nm