

## ■ Beam clamp Cast iron F9 Clamping range 29 - 69 mm Hole for M16

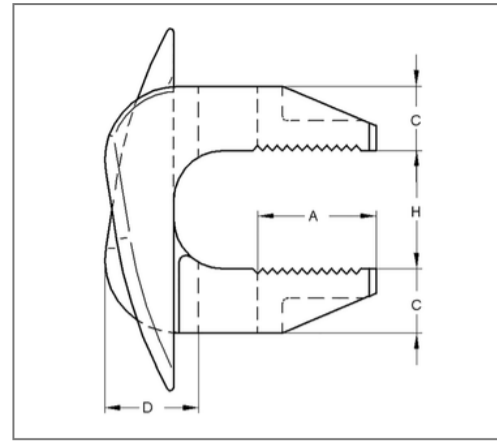
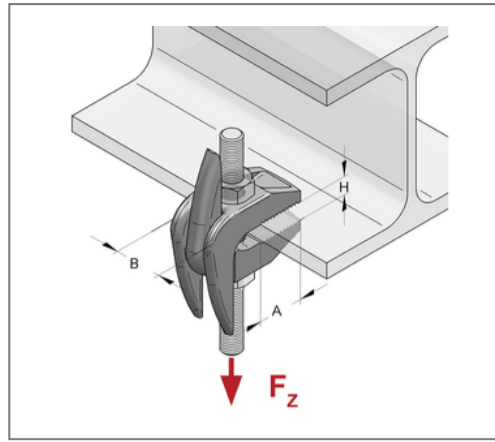
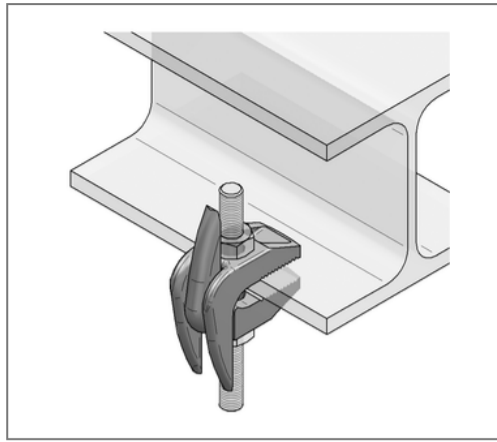

### Commercial details

Part no.	0579704
EAN/GTIN	4250928414809
Packing unit	1 pcs
Quantity unit	pcs
Weight	0,680 kg/pc
Product group	05-057
Price unit	1

### QR code



### Specification

Application area	For mounting suspensions to steel girders. Not suitable for inclined flanges.
Type of attachment	with pass hole

### Technical data

Material	Malleable cast iron
Surface	galvanized
Corrosion category	C2 very high
Surrounding area	Indoor area
min. clamping thickness H	29 mm
max. clamping thickness H	69 mm

### Product details

Load $F_z$	5,6 kN
Thread	for M16
Thickness C	21 mm
Tightening torque	93 Nm