

■ Beam clamp Cast iron TK Clamping range 1 - 26 mm M16

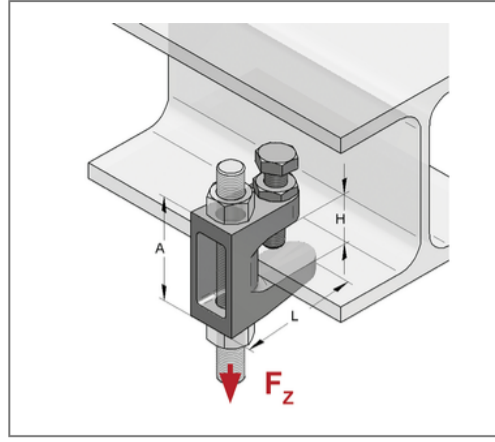
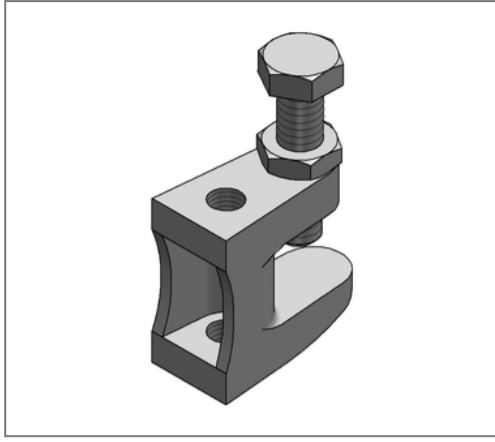

Commercial details

Part no.	0579548
EAN/GTIN	4250928414670
Packing unit	50 pcs
Quantity unit	pcs
Weight	0,399 kg/pc
Product group	05-057
Price unit	1

QR code



Certification



Specification

Brand	VS Guss
Application area	Fast and simple mounting at steel structures and profiles.
Type of attachment	with thread
Scope of delivery	Beam clamp, hexagon bolt, nut

Technical data

Material	Malleable cast iron
Surface	galvanized
Corrosion category	C2 very high
Surrounding area	Indoor area
min. clamping thickness	1 mm
max. clamping thickness	26 mm

Product details

Height	58 mm
Load F_z	5,5 kN
Thread	M16