

■ Beam clamp Cast iron TKN Clamping range 1 - 18 mm M8

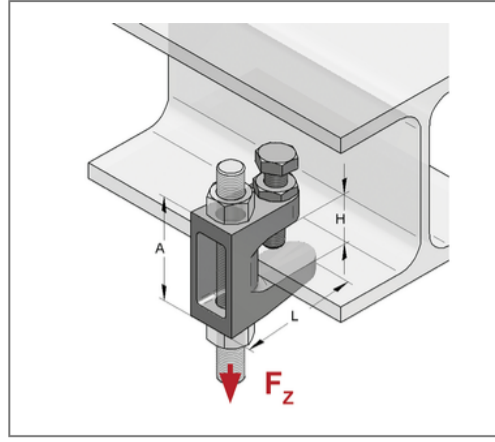
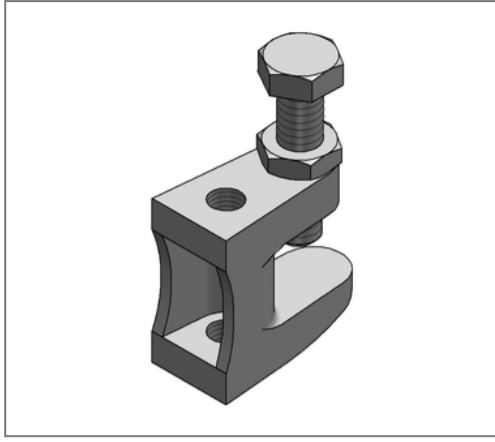

Commercial details

Part no.	0579558
EAN/GTIN	4250928414687
Packing unit	50 pcs
Quantity unit	pcs
Weight	0,0920 kg/pc
Product group	05-057
Price unit	1

QR code



Certification



Specification

Brand	VS Guss
Application area	Fast and simple mounting at steel structures and profiles.
Type of attachment	with thread
Scope of delivery	Beam clamp, hexagon bolt, nut

Technical data

Material	Malleable cast iron
Surface	galvanized
Corrosion category	C2 very high
Surrounding area	Indoor area
min. clamping thickness	1 mm
max. clamping thickness	18 mm

Product details

Height	37 mm
Load F_z	1,2 kN
Thread	M8