

■ Strap screw with washer 18 H8 x 70 mm SW 13 TX 30

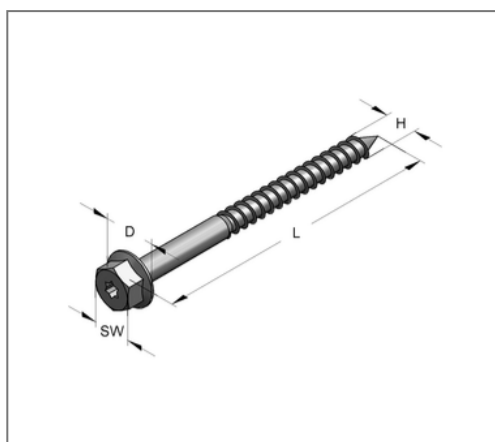

Commercial details

Part no.	350003918
EAN/GTIN	4250928448514
Packing unit	100 pcs
Quantity unit	pcs
Weight	0,0276 kg/pc
Product group	05-350
Price unit	100

QR code



Specification

Specification with contact pressed washer

Technical data

Material	Steel
Surface	galvanized
Corrosion category	C2 very high
Surrounding area	Indoor area

Product details

Thread H	H8
Length L	70 mm
Wrench size SW	13
Diameter washer D	18 mm
Type dowel	10x60
Thickness washer	2 mm
TX drive	TX 30