

■ Washer reinforced 8,4 x 35 x 3 mm galv.

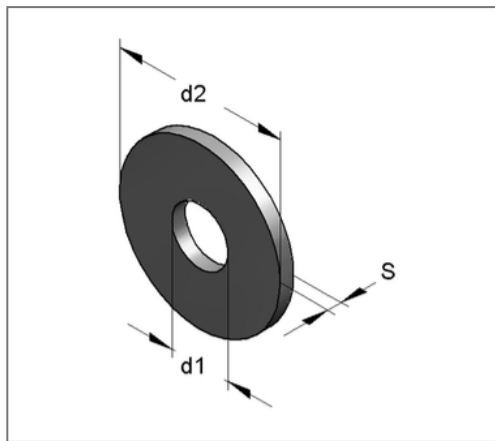
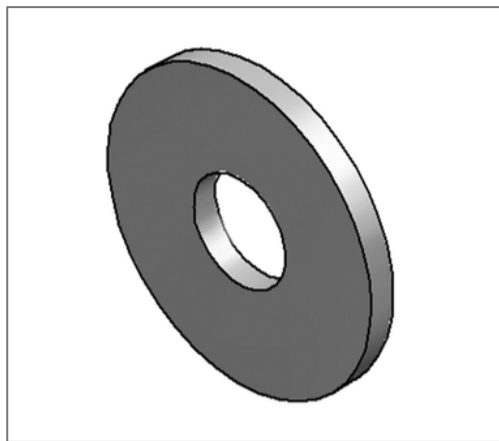

Commercial details

Part no.	4350847
EAN/GTIN	4250928439260
Packing unit	100 pcs
Quantity unit	pcs
Weight	0,0218 kg/pc
Product group	05-435
Price unit	100

QR code



Technical data

Material	Steel
Surface	galvanized
Corrosion category	C2 very high
Surrounding area	Indoor area

Product details

Inner diameter $d1$	8,4 mm
Outer diameter $d2$	35 mm
Thickness S	3 mm