

## ■ Hexagon screw EN ISO 4017 M12 x 50 mm galv. FK 8.8

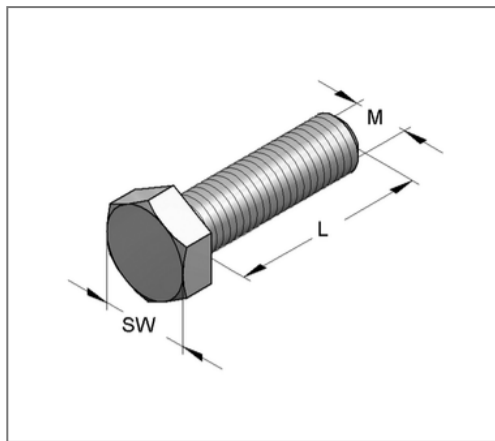
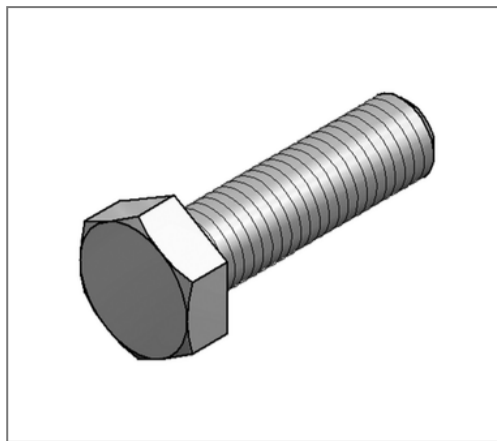

### Commercial details

Part no.	32066065
EAN/GTIN	4250928438157
Packing unit	100 pcs
Quantity unit	pcs
Weight	0,0602 kg/pc
Product group	05-320
Price unit	100

### QR code



### Technical data

Material	Steel
Surface	galvanized
Corrosion category	C2 very high
Surrounding area	Indoor area
Norm	DIN EN ISO 4017
Strength class	8.8

### Product details

Thread M	M12
Length L	50 mm
Wrench size SW	19
Shape head	Hexagon head