

■ Hexagon screw EN ISO 4017 M12 x 35 mm galv. FK 8.8

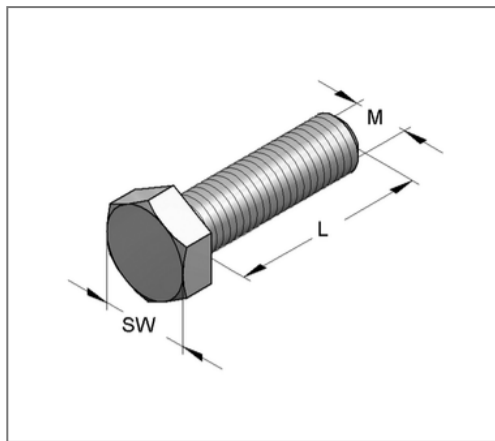
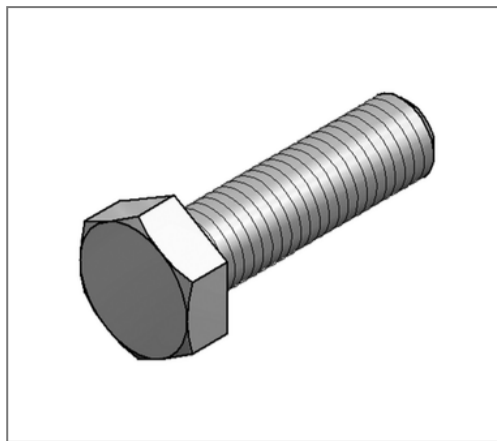

Commercial details

Part no.	3206306
EAN/GTIN	4250928438096
Packing unit	100 pcs
Quantity unit	pcs
Weight	0,0470 kg/pc
Product group	05-320
Price unit	100

QR code



Technical data

Material	Steel
Surface	galvanized
Corrosion category	C2 very high
Surrounding area	Indoor area
Norm	DIN EN ISO 4017
Strength class	8.8

Product details

Thread M	M12
Length L	35 mm
Wrench size SW	19
Shape head	Hexagon head