

■ Hexagon screw EN ISO 4017 M8 x 16 mm galv. FK 8.8

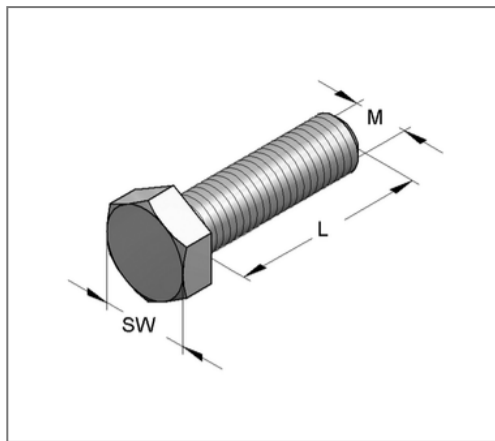
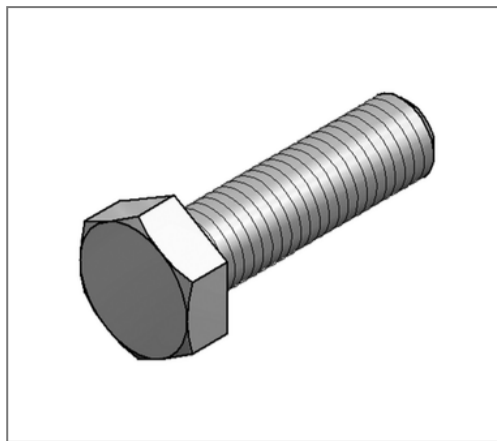

Commercial details

Part no.	3204165
EAN/GTIN	4250928437921
Packing unit	100 pcs
Quantity unit	pcs
Weight	0,0121 kg/pc
Product group	05-320
Price unit	100

QR code



Technical data

Material	Steel
Surface	galvanized
Corrosion category	C2 very high
Surrounding area	Indoor area
Norm	DIN EN ISO 4017
Strength class	8.8

Product details

Thread M	M8
Length L	16 mm
Wrench size SW	13
Shape head	Hexagon head