

## ■ Flange nut M16 SW 24

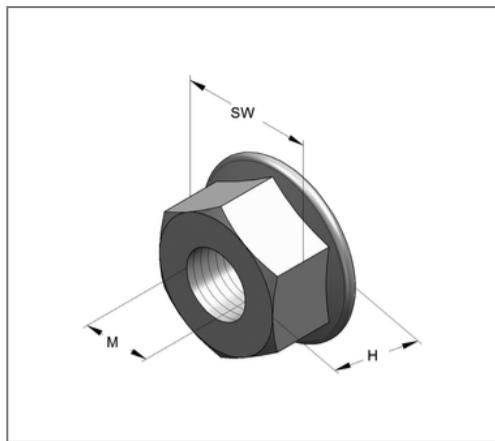
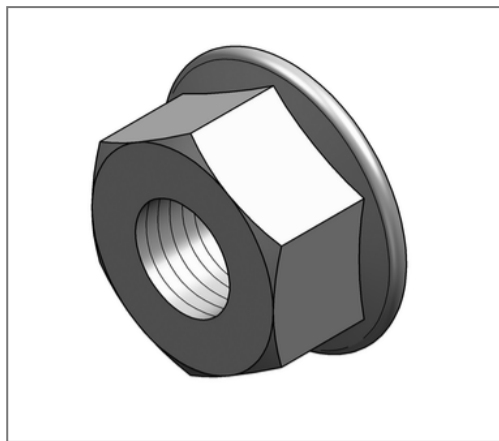

### Commercial details

Part no.	0470016
EAN/GTIN	4250928457585
Packing unit	25 pcs
Quantity unit	pcs
Weight	0,0521 kg/pc
Product group	12-047
Price unit	100

### QR code



### Technical data

Material	Steel
Surface	galvanized
Corrosion category	C2 very high
Surrounding area	Indoor area
Strength class	8
Norm	DIN 6923

### Product details

Height H	16 mm
Thread M	M16
Wrench size SW	24