

## ■ Flange nut M12 SW 18

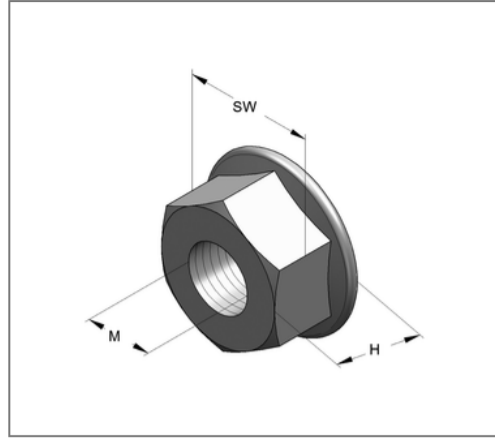
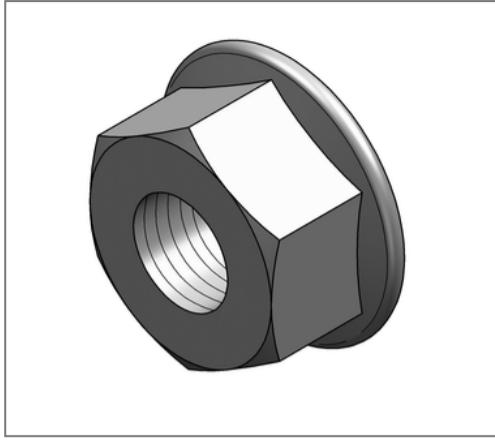

### Commercial details

Part no.	0470022
EAN/GTIN	4250928457578
Packing unit	25 pcs
Quantity unit	pcs
Weight	0,0236 kg/pc
Product group	12-047
Price unit	100

### QR code



### Technical data

Material	Steel
Surface	galvanized
Corrosion category	C2 very high
Surrounding area	Indoor area
Strength class	8
Norm	DIN 6923

### Product details

Height H	12 mm
Thread M	M12
Wrench size SW	18