

■ Hexagon nut M12 SW 19

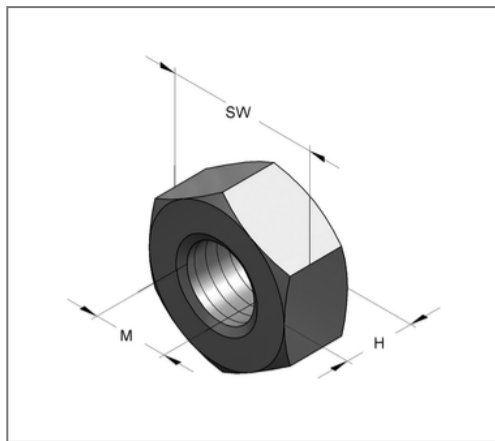
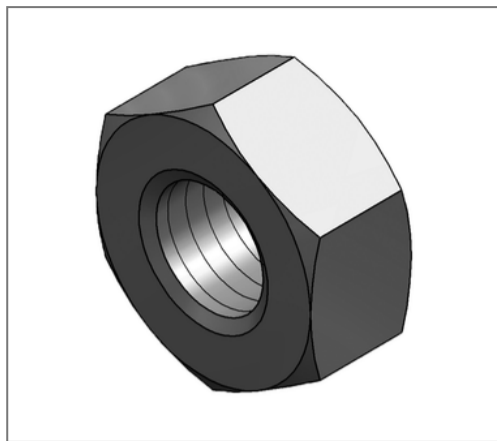

Commercial details

| | |
|---------------|---------------|
| Part no. | 4120485 |
| EAN/GTIN | 4250928438904 |
| Packing unit | 100 pcs |
| Quantity unit | pcs |
| Weight | 0,0165 kg/pc |
| Product group | 05-412 |
| Price unit | 100 |

QR code



Technical data

| | |
|--------------------|--------------|
| Material | Steel |
| Surface | galvanized |
| Corrosion category | C2 very high |
| Surrounding area | Indoor area |
| Strength class | 8 |
| Norm | DIN 934 |

Product details

| | |
|----------------|-------|
| Height H | 10 mm |
| Thread M | M12 |
| Wrench size SW | 19 |