

## ■ Reducer hexagon hexagon female thread M16 male thread M12 L=32 mm

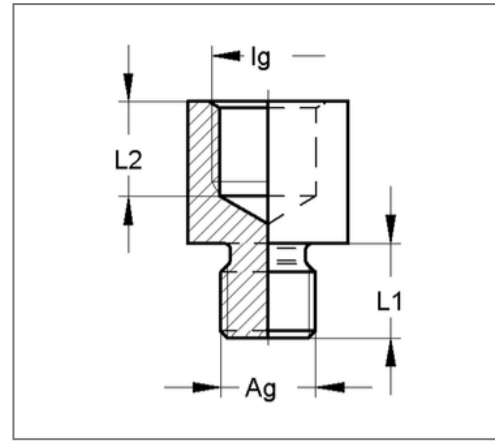
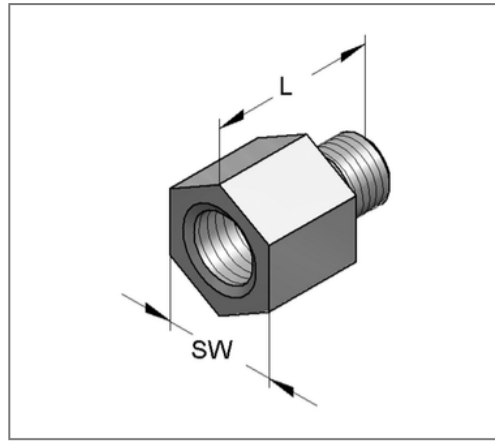
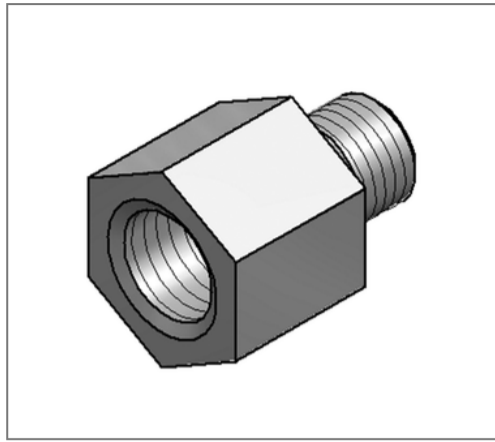

### Commercial details

Part no.	0726508
EAN/GTIN	4250928416391
Packing unit	50 pcs
Quantity unit	pcs
Weight	0,0713 kg/pc
Product group	05-072
Price unit	100

### QR code



### Technical data

Material	Steel
Surface	galvanized
Corrosion category	C2 very high
Surrounding area	Indoor area

### Product details

Length H	32 mm
Female thread Ig	M16
Length female thread L1	10 mm
Wrench size	24
Male thread Ag	M12
Length male thread L1	15 mm