

## ■ Reducer hexagon hexagon female thread M10 male thread M8 L=23 mm

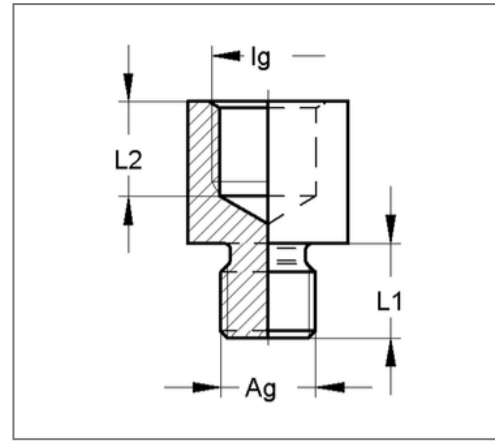
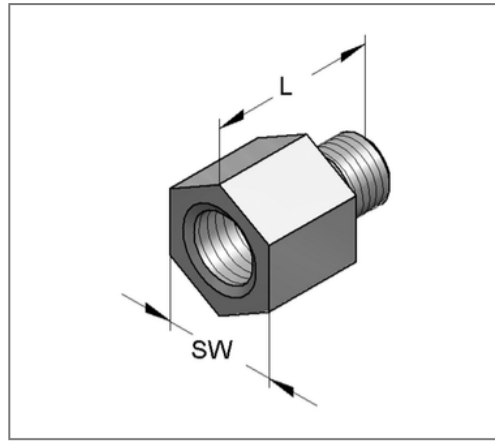
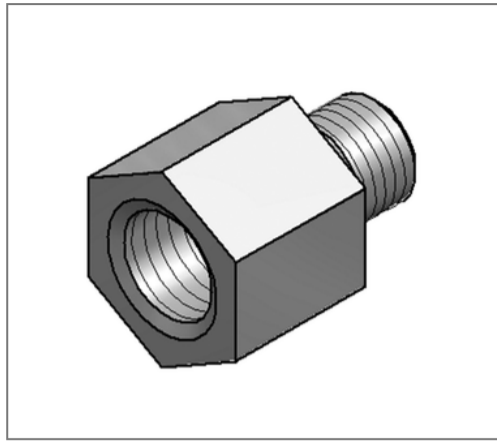

### Commercial details

Part no.	0720518
EAN/GTIN	4250928416377
Packing unit	100 pcs
Quantity unit	pcs
Weight	0,0138 kg/pc
Product group	05-072
Price unit	100

### QR code



### Technical data

Material	Steel
Surface	galvanized
Corrosion category	C2 very high
Surrounding area	Indoor area

### Product details

Length H	23 mm
Female thread Ig	M10
Length female thread L1	8 mm
Wrench size	13
Male thread Ag	M8
Length male thread L1	10 mm