

## ■ Reducer hexagon hexagon female thread M8 male thread M10 L=21 mm

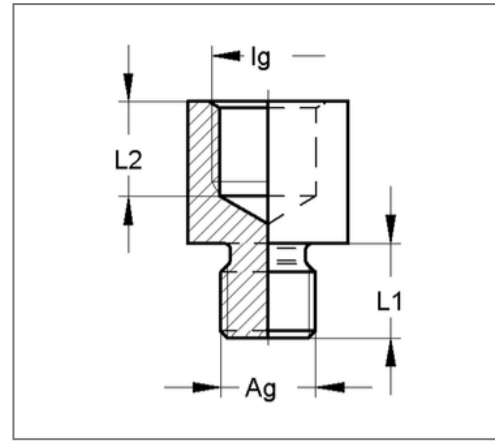
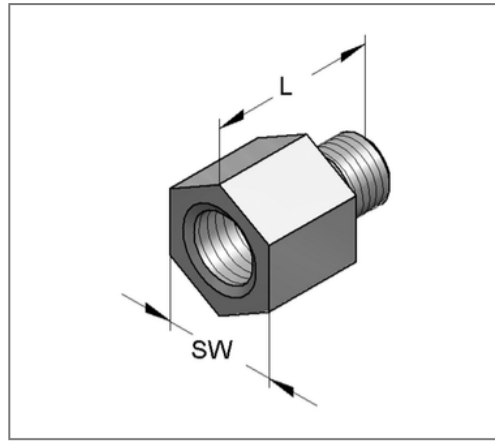
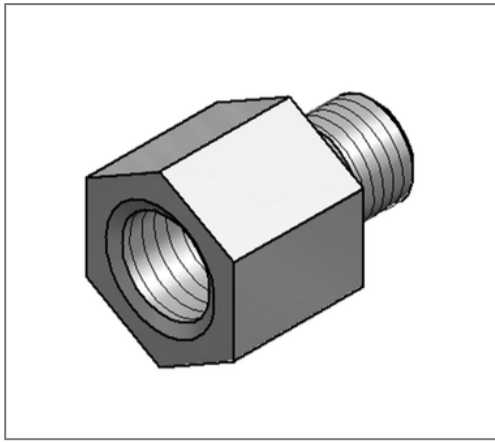

### Commercial details

Part no.	0725528
EAN/GTIN	4250928416384
Packing unit	100 pcs
Quantity unit	pcs
Weight	0,0170 kg/pc
Product group	05-072
Price unit	100

### QR code



### Technical data

Material	Steel
Surface	galvanized
Corrosion category	C2 very high
Surrounding area	Indoor area

### Product details

Length H	21 mm
Female thread Ig	M8
Length female thread L1	8 mm
Wrench size	13
Male thread Ag	M10
Length male thread L1	8 mm