

■ Threaded pin DIN 976-1 M8 x 140 mm galv. FK 4.6

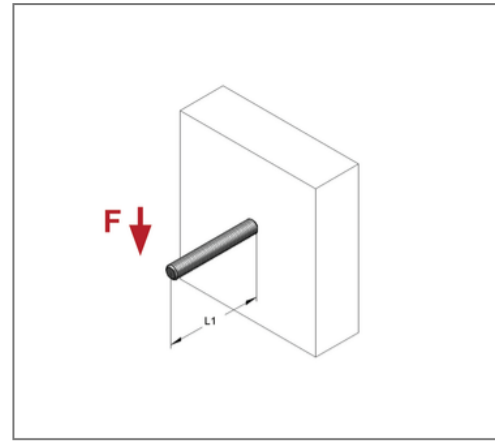
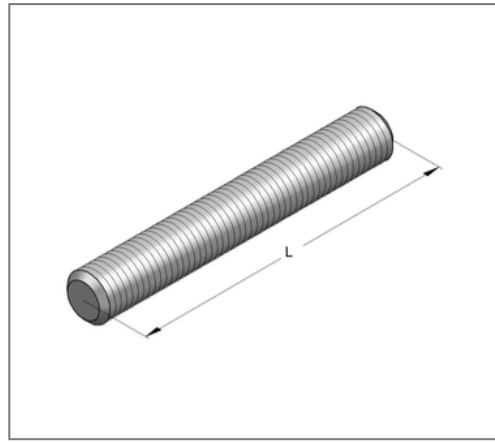
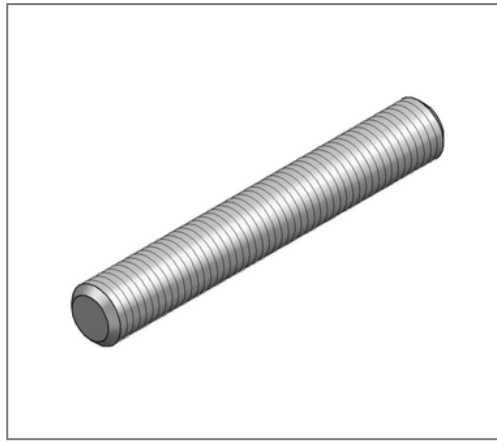

Commercial details

Part no.	0730940
EAN/GTIN	4250928416643
Packing unit	100 pcs
Quantity unit	pcs
Weight	0,0456 kg/pc
Product group	05-173
Price unit	100

QR code



Technical data

Material	Steel
Surface	galvanized
Corrosion category	C2 very high
Surrounding area	Indoor area
Strength class	4.6

Product details

Thread	M8
Length L	140 mm
Tension load	8,96 kN
Load at fire resistance period 30 min.	0,8 kN
Load at fire resistance period 60 min.	0,46 kN
Load at fire resistance period 90 min.	0,35 kN