

## ■ Threaded pin DIN 976-1 M8 x 30 mm galv. FK 4.6

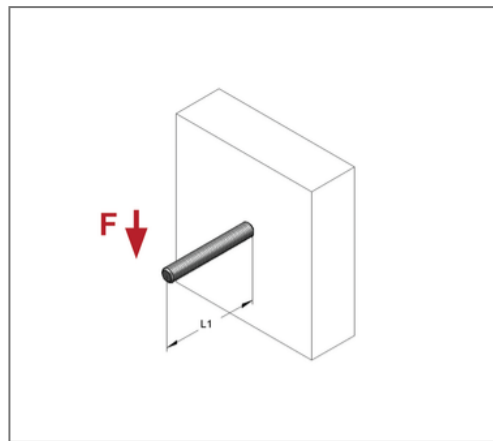
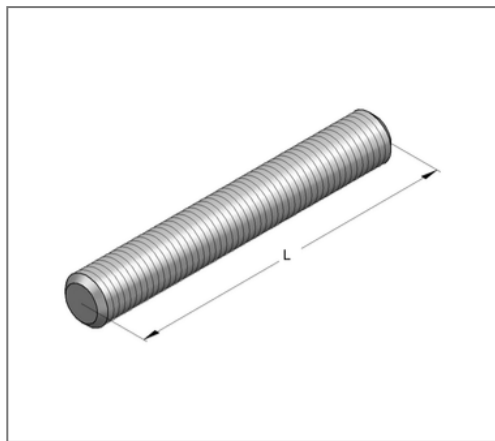
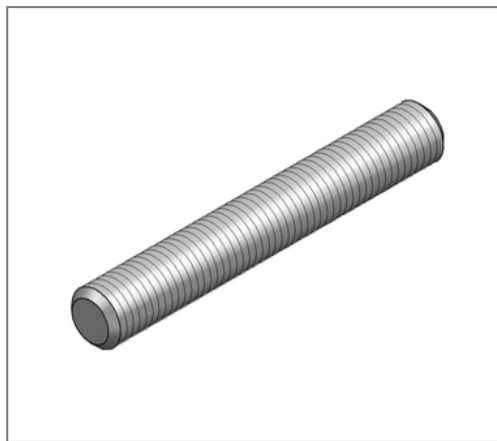

### Commercial details

Part no.	0730823
EAN/GTIN	4250928416582
Packing unit	100 pcs
Quantity unit	pcs
Weight	0,0097 kg/pc
Product group	05-173
Price unit	100

### QR code



### Technical data

Material	Steel
Surface	galvanized
Corrosion category	C2 very high
Surrounding area	Indoor area
Strength class	4.6

### Product details

Thread	M8
Length L	30 mm
Tension load	8,96 kN
Load at fire resistance period 30 min.	0,8 kN
Load at fire resistance period 60 min.	0,46 kN
Load at fire resistance period 90 min.	0,35 kN