

## ■ Distance angle single Length 40 mm Elongated hole 25x10,5 mm

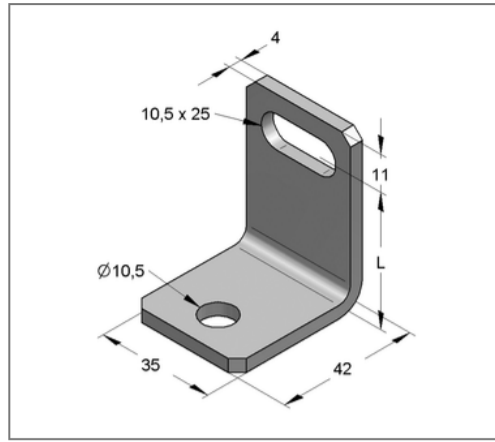
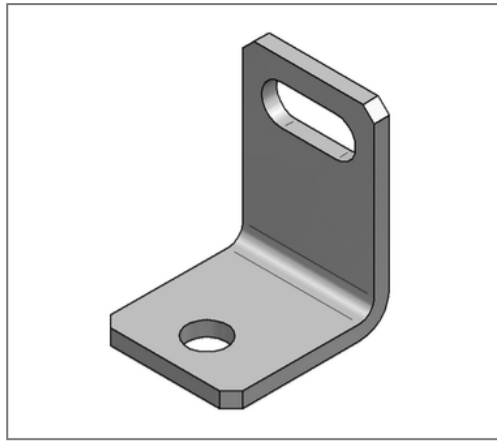

### Commercial details

Part no.	0630403
EAN/GTIN	4250928415622
Packing unit	25 pcs
Quantity unit	pcs
Weight	0,0860 kg/pc
Product group	05-063
Price unit	100

### QR code



### Specification

Application area Bracket for fixing pipe clamps with lug.

### Technical data

Material	Steel
Material type	S235
Surface	galvanized
Material thickness	4 mm
Corrosion category	C2 very high
Surrounding area	Indoor area

### Product details

Length L	40 mm
Elongated hole	10,5x25 mm
Hole-Ø	10,5 mm
Length wing	42 mm
Width wing	35 mm