

■ Trapeze hanger MU-S M12

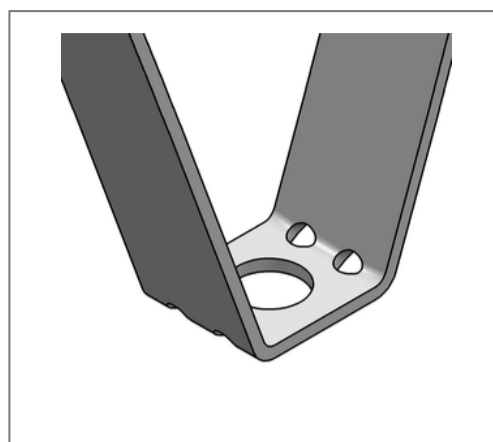
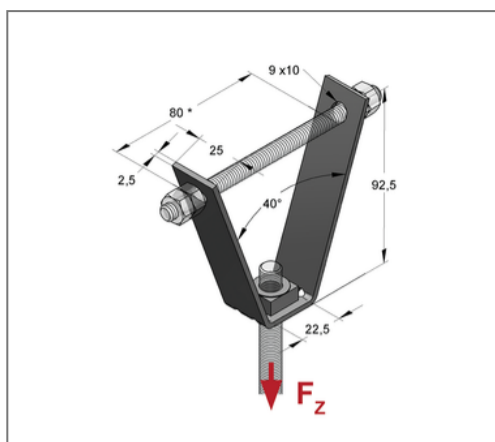
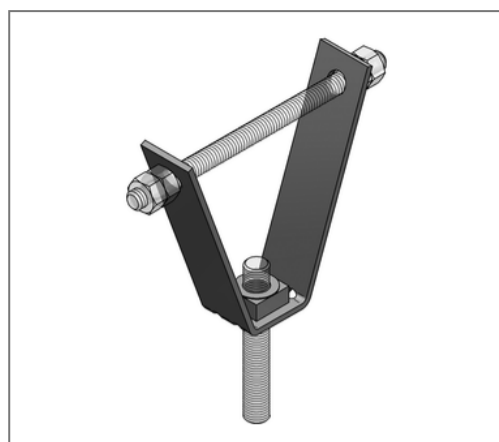

Commercial details

Part no.	0783950
EAN/GTIN	4250928418869
Packing unit	100 pcs
Quantity unit	pcs
Weight	0,121 kg/pc
Product group	05-078
Price unit	100

QR code



Specification

Application area	For mounting the pipelines, ventilation ducts and profile rails directly under a trapeze sheeting.
Specification	welded nut
Recommended accessories	threaded bolt M8 / 110, hexagon nut M8, DIN 934

Technical data

Material	Steel
Material type	S235/DD11
Surface	galvanized
Corrosion category	C2 very high
Surrounding area	Indoor area

Product details

Height	92,5 mm
Load F_z	2 kN
Material thickness	2,5 mm
Width material	25 mm
Hole-Ø	9,5 mm
Connection thread	M12
Width absorption inside	22,5 mm

Remark

Note	not VdS approved
------	------------------