

## ■ Double holder VSG with threaded pin Center distance L 46 - 154 mm

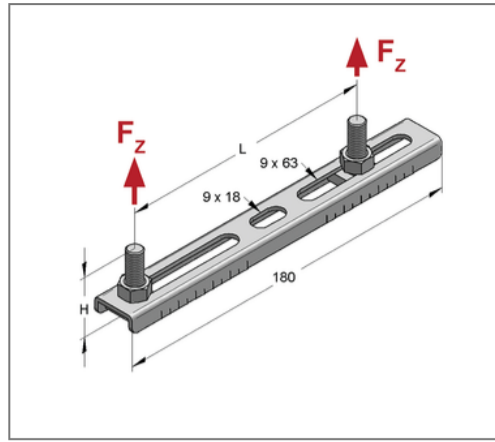
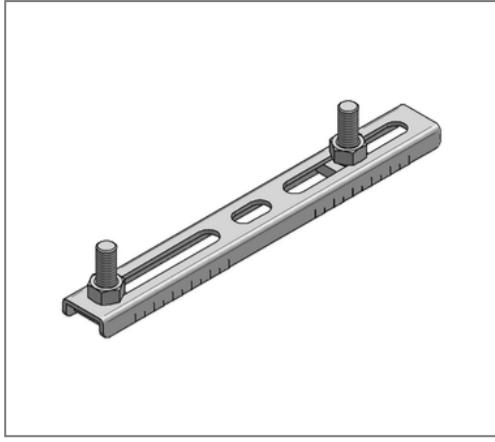

### Commercial details

Part no.	0590142
EAN/GTIN	4250928415110
Packing unit	50 pcs
Quantity unit	pcs
Weight	0,141 kg/pc
Product group	05-076
Price unit	100

### QR code



### Specification

Application area	Double holder with continuously adjustable threaded bolts.
------------------	--

### Technical data

Material	Steel
Material type	S235
Surface	galvanized
Corrosion category	C2 very high
Surrounding area	Indoor area

### Product details

Center distance L	46 - 154 mm
Height H	50 mm
Length	180 mm
Threaded pin type	M8x50
Load $F_z$	0,35 kN