

■ Base plate Type III Connection M12 Plate 137x70x8 mm

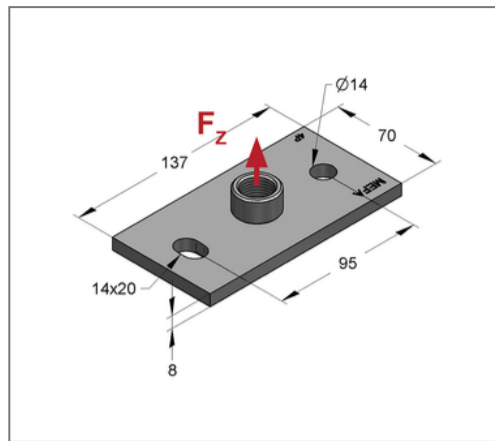
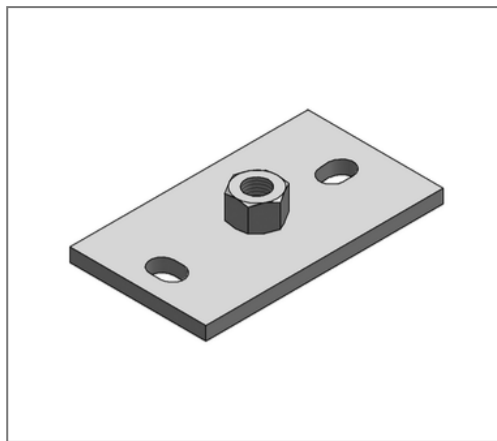

Commercial details

Part no.	059060601
EAN/GTIN	4250928447890
Packing unit	1 pcs
Quantity unit	pcs
Weight	0,606 kg/pc
Product group	05-059
Price unit	100

QR code



Specification

Number of fixing holes	2 pcs
------------------------	-------

Technical data

Material	Steel
Material type	S235
Surface	galvanized
Corrosion category	C2 very high
Surrounding area	Indoor area

Product details

Connection	M12
Length	137 mm
Width	70 mm
Thickness	8 mm
Load F_z	10 kN
Elongated hole	14x20 mm
Hole distance lengthwise	95 mm

Remark

Note	suitable sound-decoupling see chapter 3a
------	--