

■ Base plate Type II Connection M16 Plate 110x73x4 mm

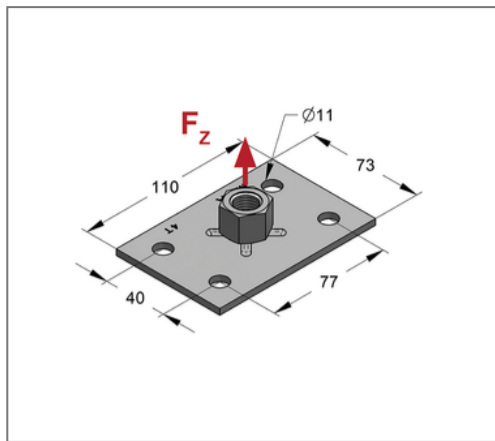
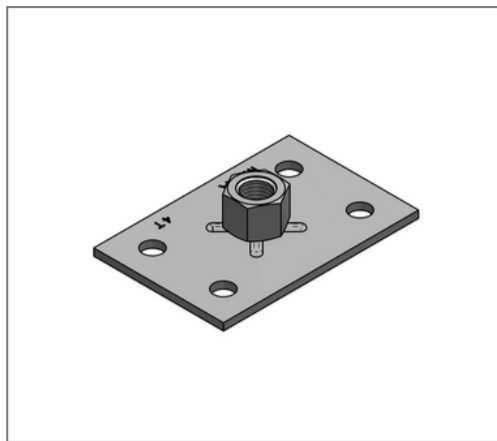

Commercial details

Part no.	059053301
EAN/GTIN	4250928457868
Packing unit	50 pcs
Quantity unit	pcs
Weight	0,301 kg/pc
Product group	05-059
Price unit	100

QR code



Specification

Number of fixing holes	4 pcs
------------------------	-------

Technical data

Material	Steel
Material type	S235
Surface	galvanized
Corrosion category	C2 very high
Surrounding area	Indoor area

Product details

Connection	M16
Length	110 mm
Width	73 mm
Thickness	4 mm
Load F_z	3,4 kN
Hole distance lengthwise	77 mm
Hole distance crosswise	40 mm